

# CHNT

Empower the World



## NA1 Air Circuit Breaker



# ABOUT CHINT



## CHINT A leading global provider of smart energy solutions

CHINT was established 38 years ago in 1984 and built from the capital of approximately 8,000 US dollars. With our rapid development these years, CHINT has become the world's leading intelligent energy solutions provider for the whole industrial chain with the most complete product ranges. In 2021, our annual sales revenue exceeded 16.1 billion dollars and total assets of more than 16.2 billion.

Over two decades of global expansion, our business network covers more than 140 countries and regions worldwide in business industries of low-voltage electric, power transmission and distribution, smart technology, energy instruments and meters, green energy, solar and more. CHINT has more than 40,000 employees worldwide, creating more than 200,000 jobs in the industrial chains.

As the market localization progresses steadily, CHINT Global further establishes its supply chain through business integration and industrial upgrade. Optimizing the service system and project financing, providing innovatively integrated technical services for the global energy market, and a flexible working business model. energy, intelligent manufacturing and digital technology, CHINT has adopted "One Cloud & Two Nets" as the business strategy, takes "CHINT Cloud" as the carrier of intelligent technology and data application, and takes the lead in building the energy Internet of things (EIoT) and industrial Internet of things platforms (IIoT).

Focusing on the energy system of supply, storage, transmission, distribution and consumption, CHINT has core businesses of clean energy, energy distribution, big data and energy value-added services. Furthermore, CHINT's pillar businesses include photovoltaic equipment, energy storage, power transmission & distribution, low-voltage apparatuses, intelligent terminals, software development and control automation. By developing into a platform-based enterprise, CHINT provides a package of energy solutions for public institutions, industrial & commercial users and end-users, by building a regional smart energy operation ecosphere.

### Main Businesses



Clean Energy



Low-voltage Apparatus



Power Transmission and Distribution



Instrumentation and Apparatus



Smart Home



Intelligent Building



Intelligent Manufacturing



Industry Automation



Smart Heating



Smart Water



Home Electrical Apparatus



Energy Efficiency Management

# ABOUT CHINT LOW VOLTAGE

Zhejiang CHINT Electrics Co., Ltd. is a wholly owned subsidiary of CHINT Group. Cultivating R&D, manufacturing and sales of low-voltage products, we provide system solutions for building, power supply, hoisting, HVAC, telecommunication and other industrial customers. For nearly 40 years since its founding, CHINT Electrics has provided reliable products and services to over 140 countries and regions. Today, CHINT has grown to be one of the world's renowned low-voltage brands.

## CHINT Honors

2022

- "AAAAA" standardized good behavior certificate
- "Global Partnership" and "Countries along the Belt and Road" in the "2021 Best Practices for Realizing the Sustainable Development Goals".
- CSR Impact Leading Enterprise

2021

- No. 1 in "China's Top 100 Private Enterprises with Social Responsibility" in 2021
- For 8 consecutive years, CHINT has won the sales champion of Tmall double 11 in electrical and hardware industry
- No. 92 in "2021 China's Top 500 Private Enterprises".
- No. 244 in "2021 Top 500 Chinese Enterprises"
- The intelligent manufacturing factory of low-voltage electrical appliances was selected as the national "2021 Intelligent Manufacturing Demonstration Factory".

2020

- CHINT was selected in the 2020 Zhejiang Province "Future Factory" recognized list, and was rated as the leading "Leading Goose Factory".
- The key inverter technology of CHINT won the second prize of China Electric Power Science and Technology.
- CHINT Astrometry was selected as the smart PV demonstration enterprise list of the Ministry of Industry and Information Technology and won the honor of "Influential PV cell/module brand", "Influential PV EPC / End User", "Influential PV power station operation and maintenance brand".

2019

- National Green Factory
- National Industrial Design Center of the MIIT
- Global Top 20 PV Enterprise
- China's Top 10 Successful PV Enterprise
- Top 100 Innovative Enterprises in Zhejiang Province
- Technology innovation system was awarded the 2018 Science and Technology Progress Award in Zhejiang

## Qualification Certification

The products have been accredited through China Compulsory Certification (CCC) as well as UL of US, CE of EU, VDE and TÜV of Germany, KEMA of Netherlands, RCM of Australia, RCC of South Africa and other international product certifications.





# R&D, QUALITY, SALES, LOGISTICS

## Main Advantages

### Global R&D System

CHINT has established national R&D centers in North America, Europe, Asia Pacific, North Africa and other areas. We have explored the mode of Industry-University Research Institute Collaboration and Integration together with the universities and research institutions worldwide so as to integrate the global innovation resources and promote corporate R&D innovation and talent cultivation.



24 research institutes



The average annual R&D investment accounts for 4-12% of the revenue



Over 6000 patents in total

## Global Certification

The products have passed the standards and specifications in various regions around the world and obtained numerous international certifications



## Honors

- No. 1 in China's Top 100 Private Enterprises with Social Responsibility in 2021
- No. 92 in 2021 China's Top 500 Private Enterprises
- No. 244 in 2021 Top 500 Chinese Enterprises
- The intelligent manufacturing factory of low-voltage electrical appliances was selected as the national 2021 Intelligent Manufacturing Demonstration Factory



### Integrated Vertical R&D

By gathering the global industry elites to Provide safe and stable energy-saving green and advanced electric products.

### Great Quality System

Ensuring flaw-free and trouble-free products, the multi-dimensional and multilevel control is conducted through procurement, inspection, quality control and certification.

### One-stop Services

CHINT's concept is that it is not difficult to fulfill a high-quality logistics distribution at one time, while it is difficult to stay as accurate and prompt as the first-time. High-efficiency and high-precision accuracy are our requirement.

### 48-Hour Response

Providing end-to-end one-stop services for customers with complains, business consulting and technical support by solving problems immediately and including any possible problems in advance.



At least 5% of revenue is invested in research and development





# Air Circuit Breaker

---

## ACB

---



NA8



NA1

---





NA1-1000X  
200A to 1000A



2000XN, NA1-2000XH  
630A to 2000A



NA1-3200X, NA1-3200XN, NA1-4000X  
2000A to 4000A



NA1-6300X, NA1-6300XN  
4000A to 6300A



## Summary

### Basic frame sizes

For your various requirements, the Air Circuit Breaker NA1 includes 5 basic frame sizes as followed. NA1-2000X, NA1-

**1. General**

**1.1 Application scope**

NA1 series air circuit breaker is suitable for the circuit of AC 50Hz/60Hz with rated service voltage 400V, 690V and rated service current up to 6300A. It is mainly used to distribute electric energy and protect circuits and electric equipment against over-load, under-voltage, short-circuit and single-phase earthing fault.

With intelligentized and selective protection functions, the breaker can improve the reliability of power supply, and avoid unnecessary power failure. The breaker is applicable for power stations, factories, mines (for 690V) and modern high-buildings, especially for the distribution system of intelligentized building.

**1.2 Standard: IEC/EN 60947-2.**

**2. Operating conditions**

**2.1 Temperature condition:**

-5 °C ~40 °C ; the average value within 24h shall not exceed +35°C (special situation excluded);

**2.2 Altitude: ≤2000m;**

**2.3 Pollution grade: Grade 3;**

**2.4 Air conditions:**

At mounting site, relative humidity not exceed 50% at the max temperature of +40 °C , higher relative humidity is allowable under lower temperature, RH could be 90% at +20 °C , special measures should be taken to occurrence of dews;

**2.5 Note: Without the intelligent controller, the breaker functions as a switch-disconnector.**

**2.6 Type designation**

NA1 - □□ - □□ / □ - □ - □ - □ - □

Voltage of secondary circuit  
AC220V, AC380V,  
AC230V, AC400V  
DC220V, DC110V

Wiring of main circuit:  
H:Horizontal wiring of main circuit  
V:Vertical wiring of main circuit

Mode of installation:  
F:Fixed type  
D:Draweout type

Mode of operation:  
M:Manual  
P: Power-driven

No. of poles:  
3:3-pole  
4:4-pole

Intelligent controller:  
M: Standard type  
3M:Multifunctional type  
H/3H:Communication type<sup>1)</sup>

Rated current:

Frame size rated current	Rated current
1000A	200A
	400A
	630A
	800A
	1000A
2000A	630A
	800A
	1000A
	1250A
	1600A
	2000A
3200A	2000A
	2500A
	3200A
4000A	4000A
6300A	4000A
	5000A
	6300A

Breaking capacity:  
X  
XN  
XH

Frame size rated current:  
1000,2000,3200,4000,6300

Design sequence number

ACB

Company code

Note: 1) In model selection, H indicates 3H type, please mark in order when H type controller is needed



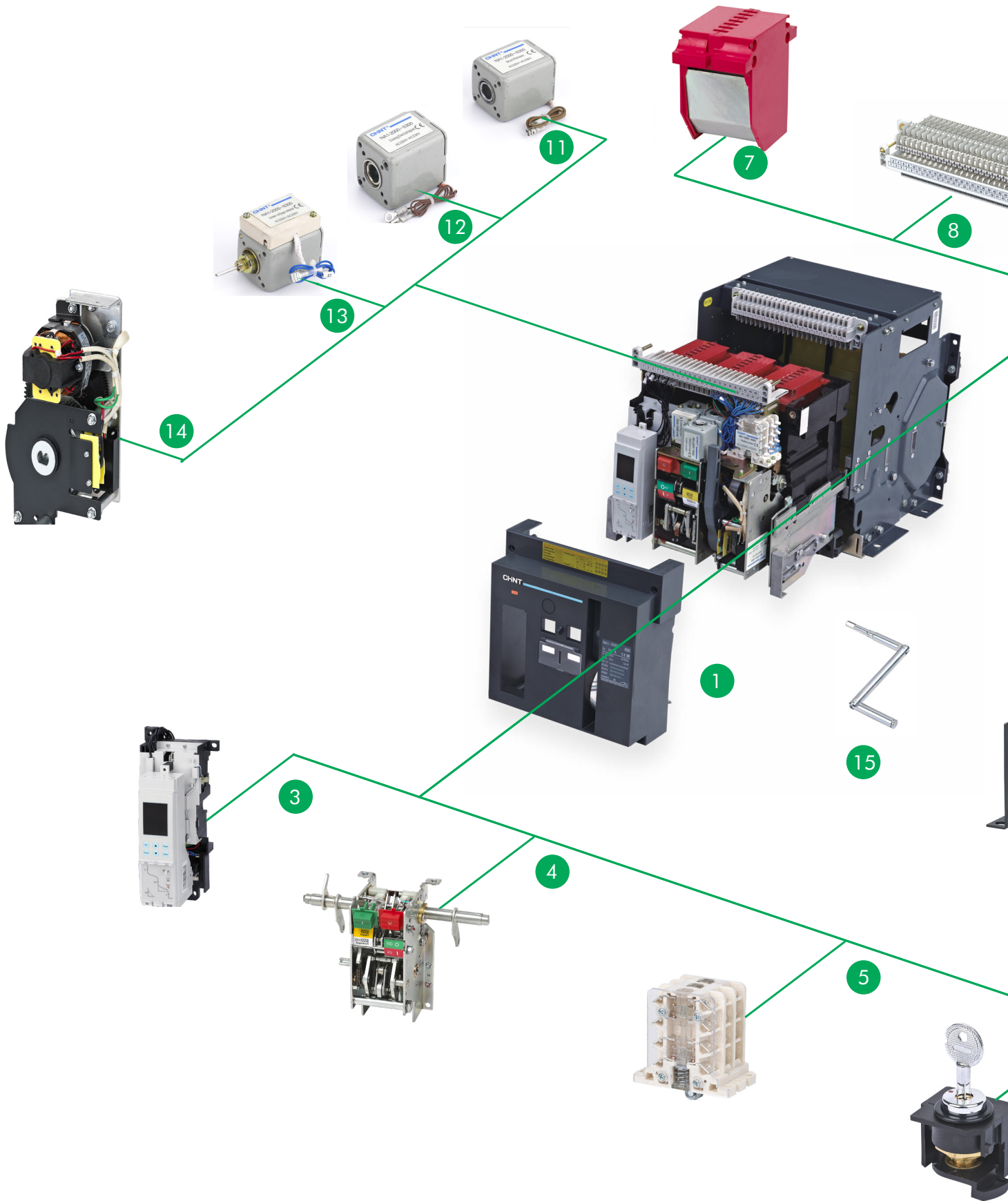

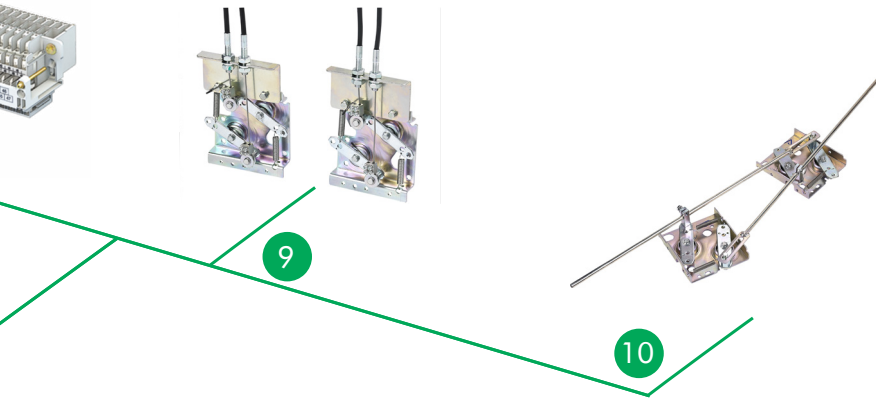



## NA1 Air Circuit Breaker

- 1 Drawout type
- 2 Fixed type
- 3 Intelligent controller
- 4 Operating mechanism
- 5 Auxiliary contact
- 6 Locking-device
- 7 Arcing chamber
- 8 Secondary wiring terminal
- 9 Wire-cable mechanical interlock
- 10 Connecting-rod type mechanical interlock
- 11 Shunt release
- 12 Closing electromagnet
- 13 Under-voltage release
- 14 Motor-driven energy-storage mechanism
- 15 Rotary handle
- 16 Mounting plate

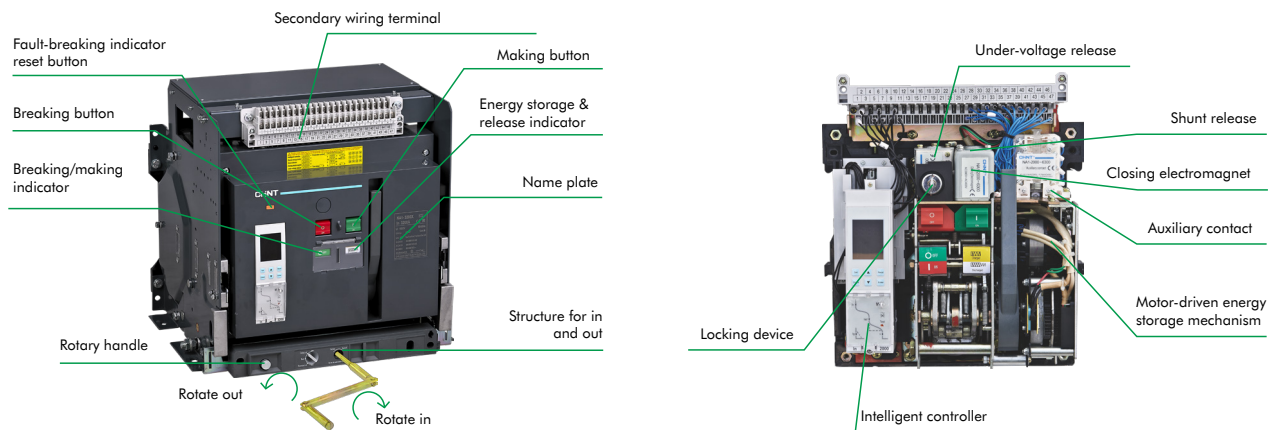
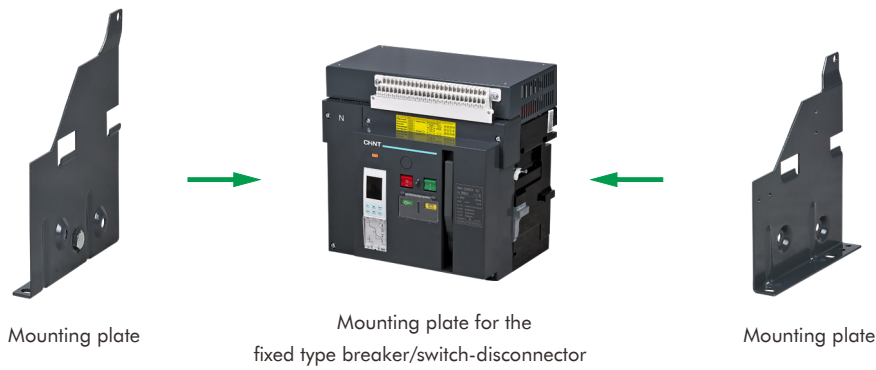
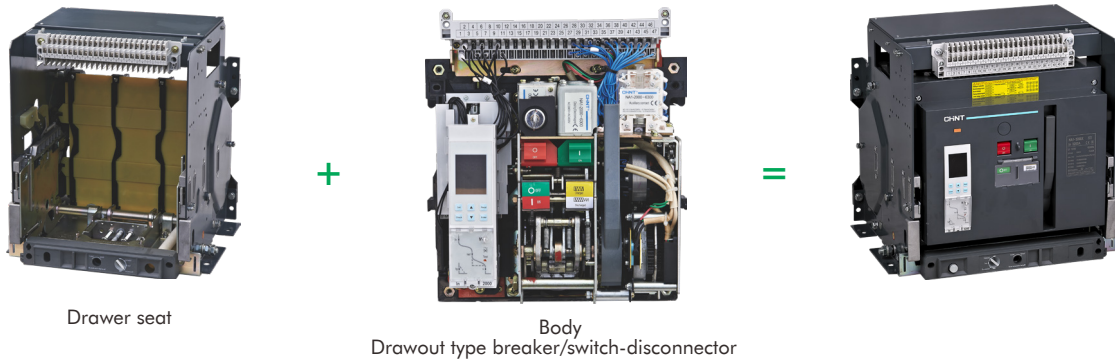

### 3. Structure



#### 4. Main technical parameter

Type		NA1-1000X				
						
Rated ultimate short circuit breaking capacity (Icu)	AC400V	42				
	AC690V	25				
Rated service short circuit breaking capacity (Ics)	AC400V	30				
	AC690V	20				
Rated short-time withstand current (Icw.1s)	AC400V	30				
	AC690V	20				
Rated current In (A)		200	400	630	800	1000
Number of poles		3, 4				
Rated voltage Ue (V)		AC 400, AC 690				
Rated insulation voltage Ui (V)		800				
Rated current of N-pole In (A)		100%In				
Intelligent controller	Standard type (M)	●	●	●	●	●
	Communication type (H)	●	●	●	●	●
Operation performance	Electric life	AC 400V:6500, AC 690V:3000				
	Mechanical life	Non-maintenance 15,000 Maintenance 30,000				
Connection pattern		Horizontal, Vertical				
Total breaking time (no additional delay time) (ms)		≤28				
Closing time(ms)		≤50				
Arcing distance(mm)		0				

Type		NA1-2000X	NA1-2000XN				NA1-2000XH
							
Rated ultimate short circuit breaking capacity (Icu)	AC400V	80		50			65
	AC415V	50		40			50
	AC690V	50		40			50
Rated service short circuit breaking capacity (Ics)	AC400V	65		50			65
	AC415V	40		40			40
	AC690V	40		40			40
Rated short-time withstand (Icw.1s)	AC400V	50		50			50
	AC415V	40		40			40
	AC690V	40		40			40
Rated short-time withstand (Icw.3s)	AC400V	42		42			42
	AC415V	42		42			42
Rated current I <sub>n</sub> (A)		630	800	1000	1250	1600	2000
Number of poles		3, 4					
Rated voltage U <sub>e</sub> (V)		AC400, AC415, AC690					
Rated insulation voltage U <sub>i</sub> (V)		1000					
Rated current of N-pole I <sub>n</sub> (A)		100%I <sub>n</sub>					
Intelligent controller	Standard type (M)	●	●	●	●	●	●
	Communication type (H)	●	●	●	●	●	●
Operation performance	Electric life	AC400:6500		AC690V:3000			
	Mechanical life	Non-maintenance 15,000					
		Maintenance 30,000					
Connection pattern		Horizontal, Vertical					
Total breaking time (no additional delay time) (ms)		≤28					
Closing time(ms)		≤50					
Arcing distance(mm)		0					

Type		NA1-3200X	NA1-3200XN	NA1-4000X	
		 			
Rated ultimate short circuit breaking capacity (Icu)	AC400V	80	65	80	
	AC415V	65	50	—	
	AC690V	65	50	65	
Rated service short circuit breaking capacity (Ics)	AC400V	65	65	65	
	AC415V	65	50	—	
	AC690V	65	50	65	
Rated short-time withstand (Icw.1s)	AC400V	65	65	65	
	AC415V	50	50	—	
	AC690V	50	50	50	
Rated short-time withstand (Icw.3s)	AC400V	45	45	—	
	AC415V	45	45	—	
Rated current I <sub>n</sub> (A)		2000	2500	3200	4000
Number of poles		3, 4			3
Rated voltage U <sub>e</sub> (V)		AC400, AC415, AC690			
Rated insulation voltage U <sub>i</sub> (V)		1000			
Rated current of N-pole I <sub>n</sub> (A)		100%I <sub>n</sub>			
Intelligent controller	Standard type (M)	●	●	●	●
	Communication type (H)	●	●	●	●
Operation performance	Electric life	AC400V:3000 AC690V:2000			
	Mechanical life	Non-maintenance 10,000 Maintenance 20,000			
Connection pattern		Horizontal, Vertical			
Total breaking time (no additional delay time) (ms)		≤28			
Closing time(ms)		≤50			
Arcing distance(mm)		0			



Type		NA1-6300X	NA1-6300XN	
				
Rated ultimate short circuit breaking capacity (Icu)	AC400V	120	100	
	AC415V	85	75	
	AC690V	85	75	
Rated service short circuit breaking capacity (Ics)	AC400V	100	100	
	AC415V	75	75	
	AC690V	75	75	
Rated short-time withstand (Icw.1s)	AC400V	100	100	
	AC415V	75	75	
	AC690V	75	75	
Rated short-time withstand (Icw.3s)	AC400V	50	50	
	AC415V	50	50	
rated current In (A)		4000	5000	6300
Number of poles		3, 4		3
Rated voltage Ue (V)		AC400, AC415, AC690		
Rated insulation voltage Ui (V)		1000		
Rated current of N-pole In (A)		50%In		—
Intelligent controller	Standard type (M)	●	●	●
	Communication type (H)	●	●	●
Operation performance	Electric life	AC400V:1500 AC690V:1000		
	Mechanical life	Non-maintenance 5000 Maintenance 10,000		
Connection pattern		Horizontal, Vertical		
Total breaking time (no additional delay time) (ms)		≤28		
Closing time(ms)		≤50		
Arcing distance(mm)		0		

Weight of single product (net weight)										
Weight (kg)	Model Spec.	NA1-2000X(3/4)			NA1-3200X(3/4)		NA1-4000X/3	NA1-6300X(3/4)		
		NA1-1000X(3P/4P)	630	800~1600	2000	2000~2500		3200	4000~5000	6300
Installation method										
Fixed type		21/25	44/53	45/54	46/55	57/69	59/72	91	-/-	-/-
Drawer type		38/45	67/82	73/85	75/90	96/118	106/130	135	201/233	235/-

5. Dimensions and connection

NA1-1000X Fixed-type

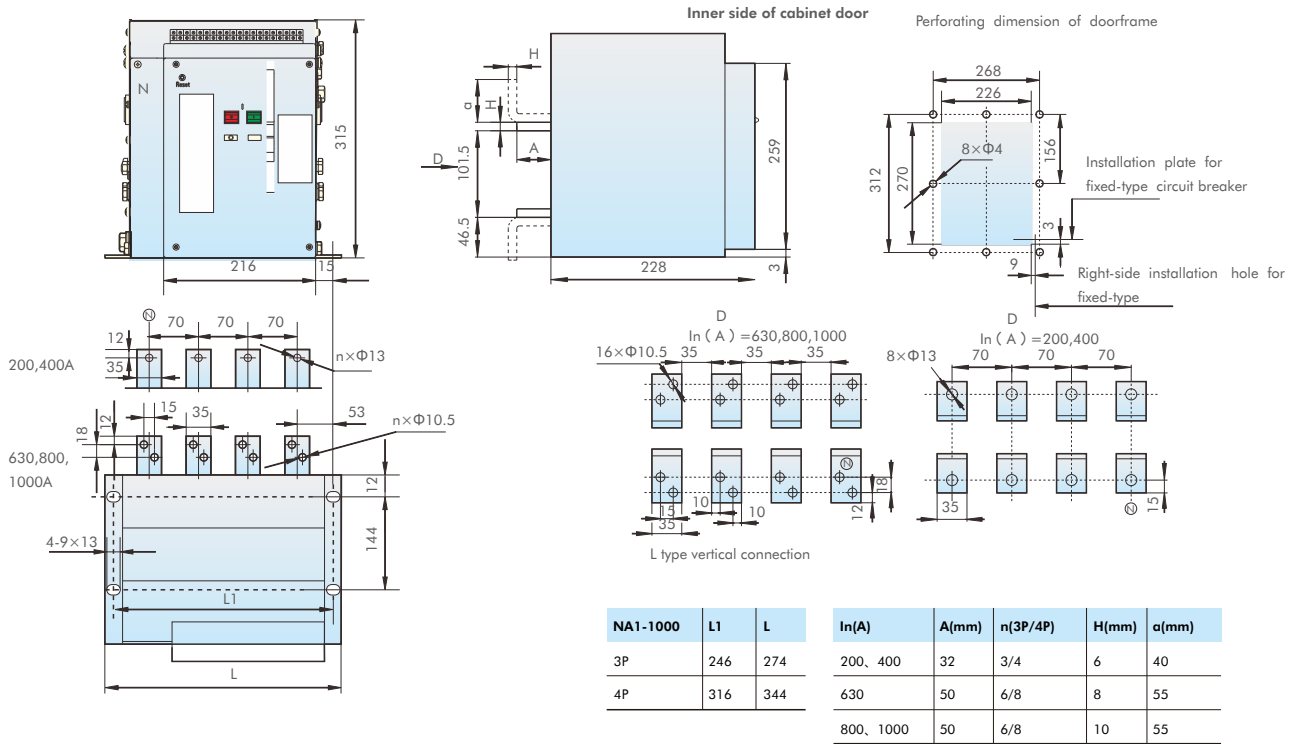

NA1-1000X Drawout-type

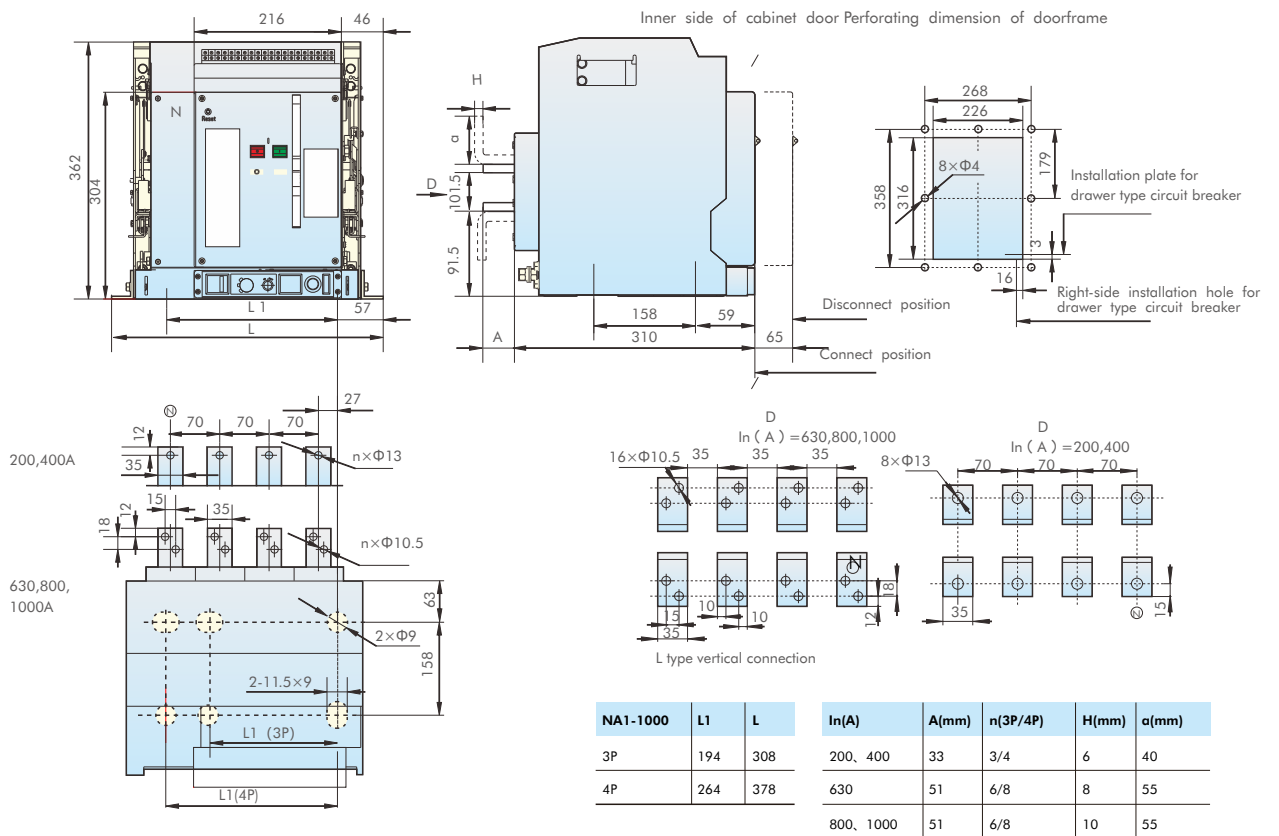

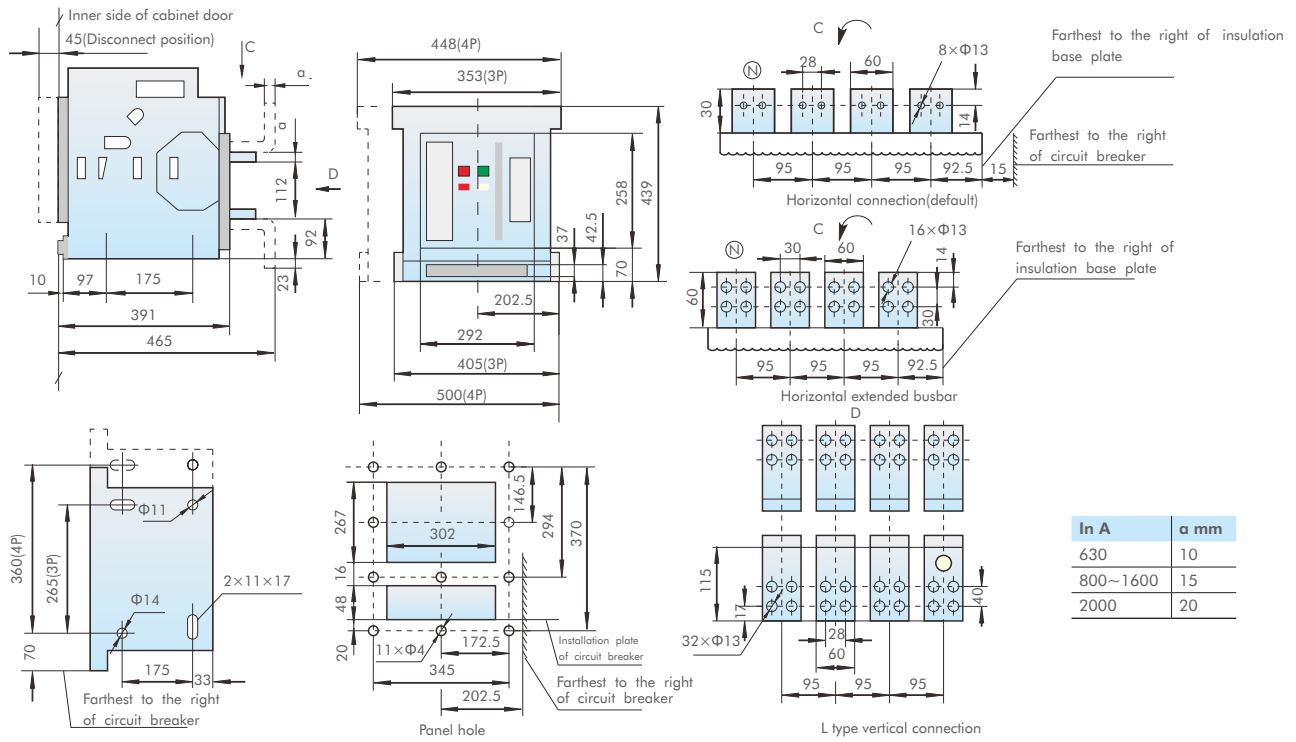

NA1-2000X/NA1-2000XN/NA1-2000XH Drawout-type,vertical,rear connection,rotation busbar

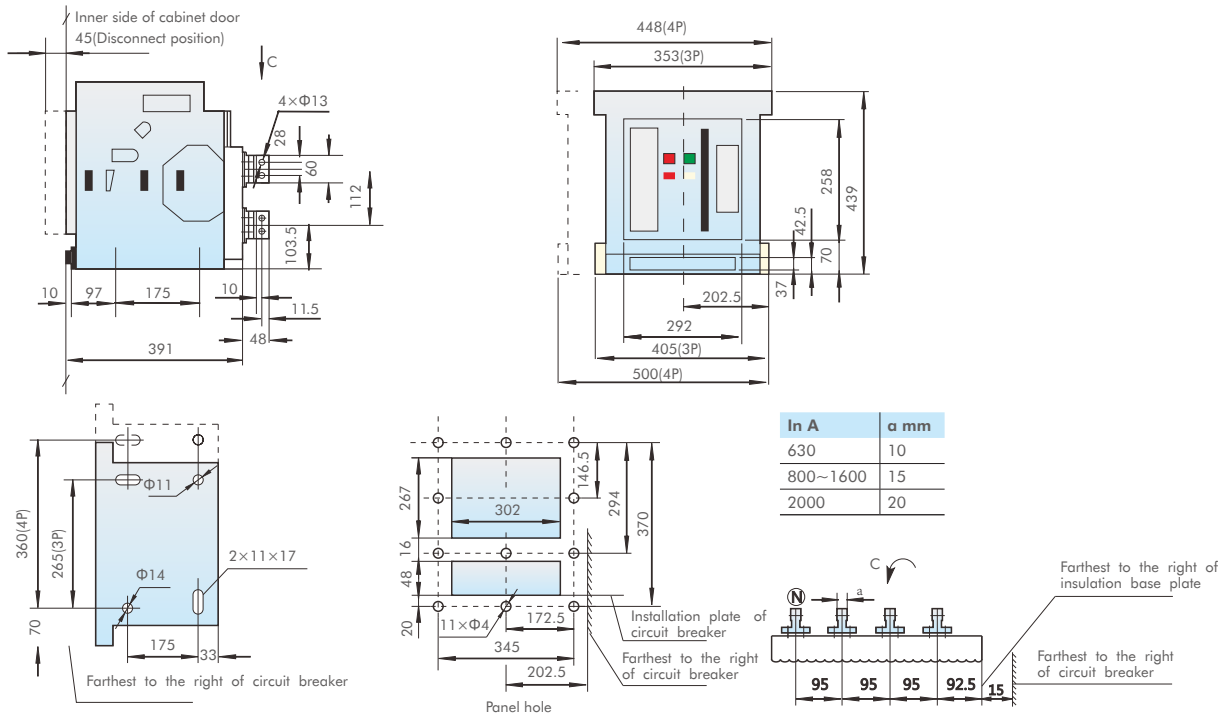

User only needs to rotate the busbar for 90° to change from vertical connection to horizontal connection onsite.



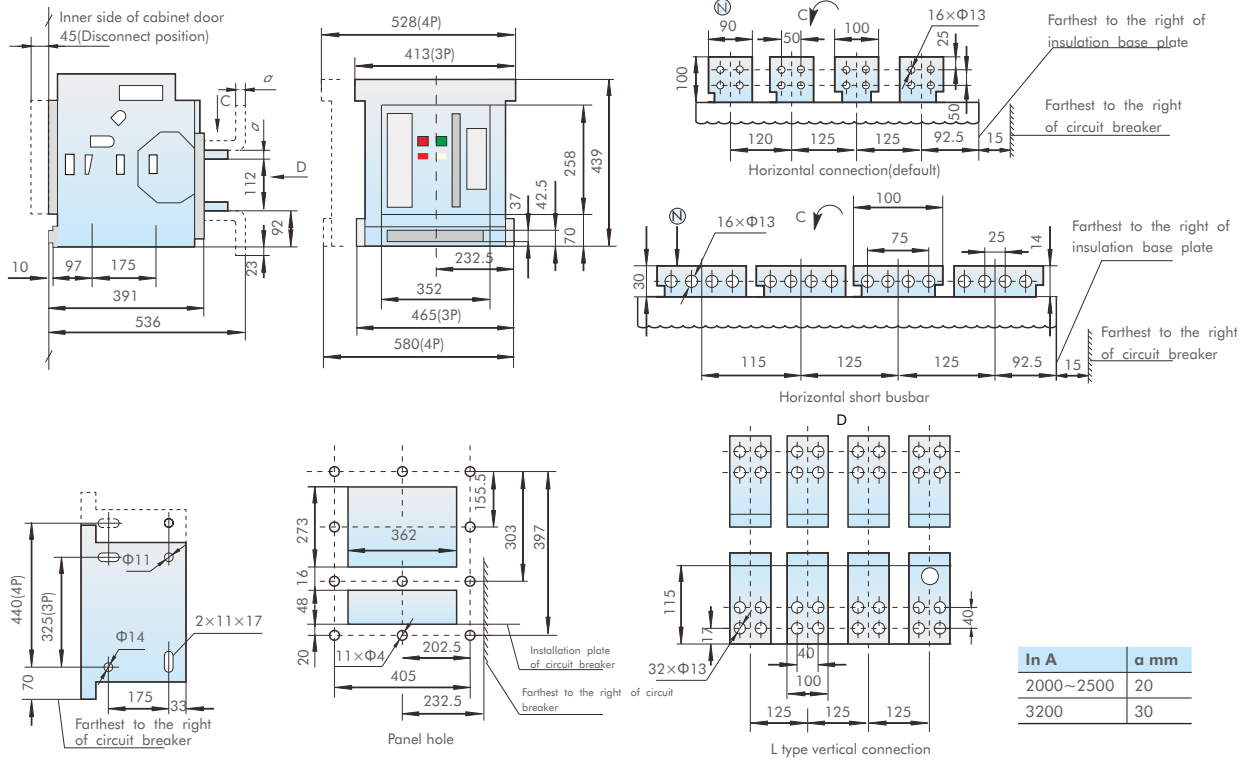

NA1-3200X/NA1-3200XN Drawout-type,vertical,rear connection,rotation busbar

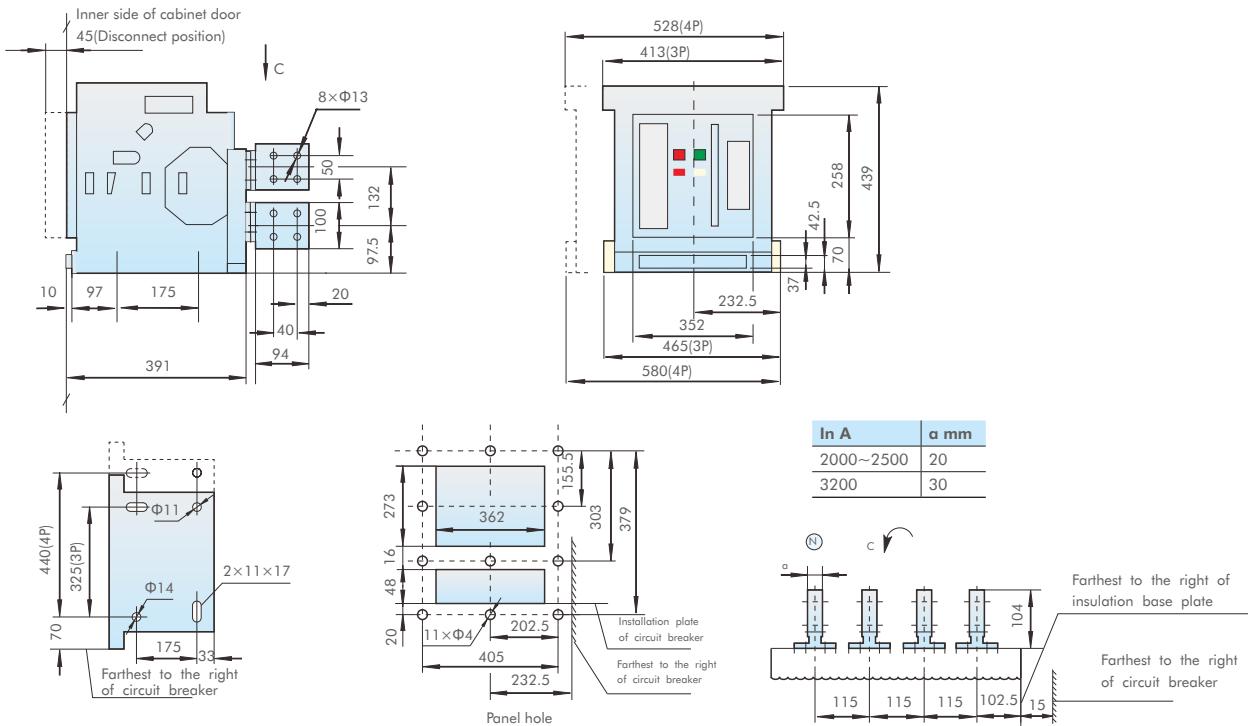

Note: In order to change vertical connection to horizontal connection onsite, user needs to change the upper and lower busbars of phase B so they are different from those of phase A and phase C.

NA1-3200x/NA1-3200xN Drawout-type, horizontal, rear connection, rotation busbar

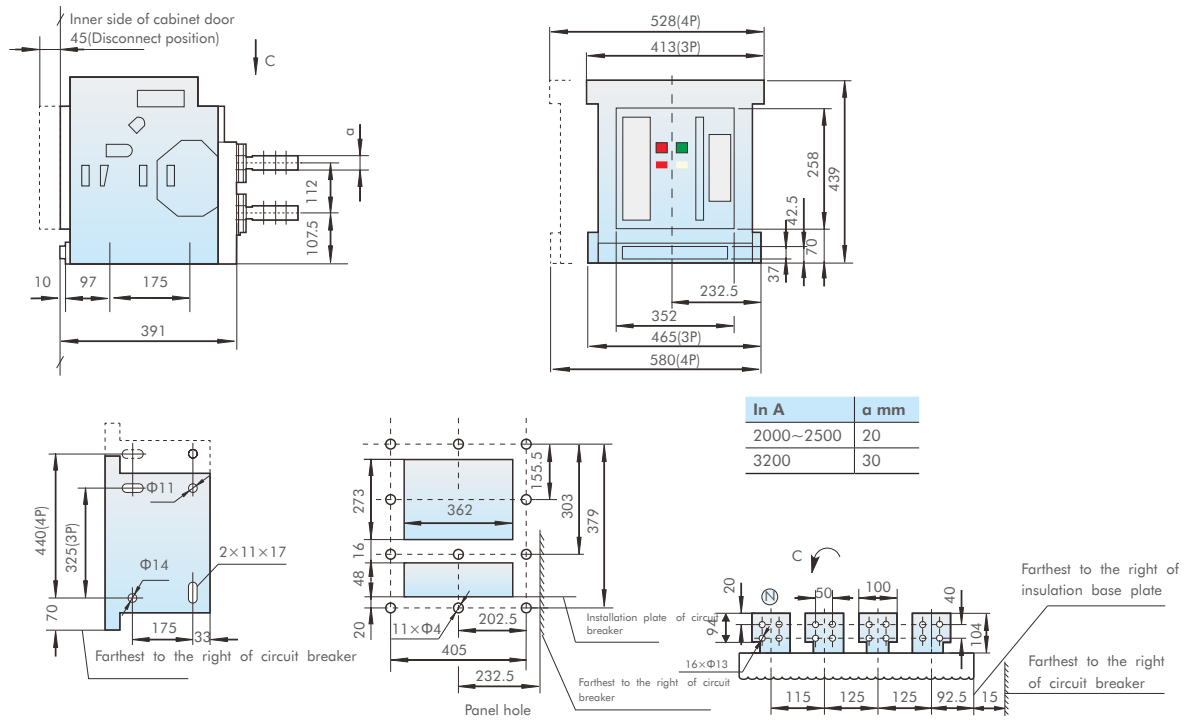

Note: In order to change horizontal connection to vertical connection onsite, user needs to change the upper and lower busbars of phase B so they are different from those of phase A and phase C.

NA1-3200X/NA1-3200xN Fixed-type

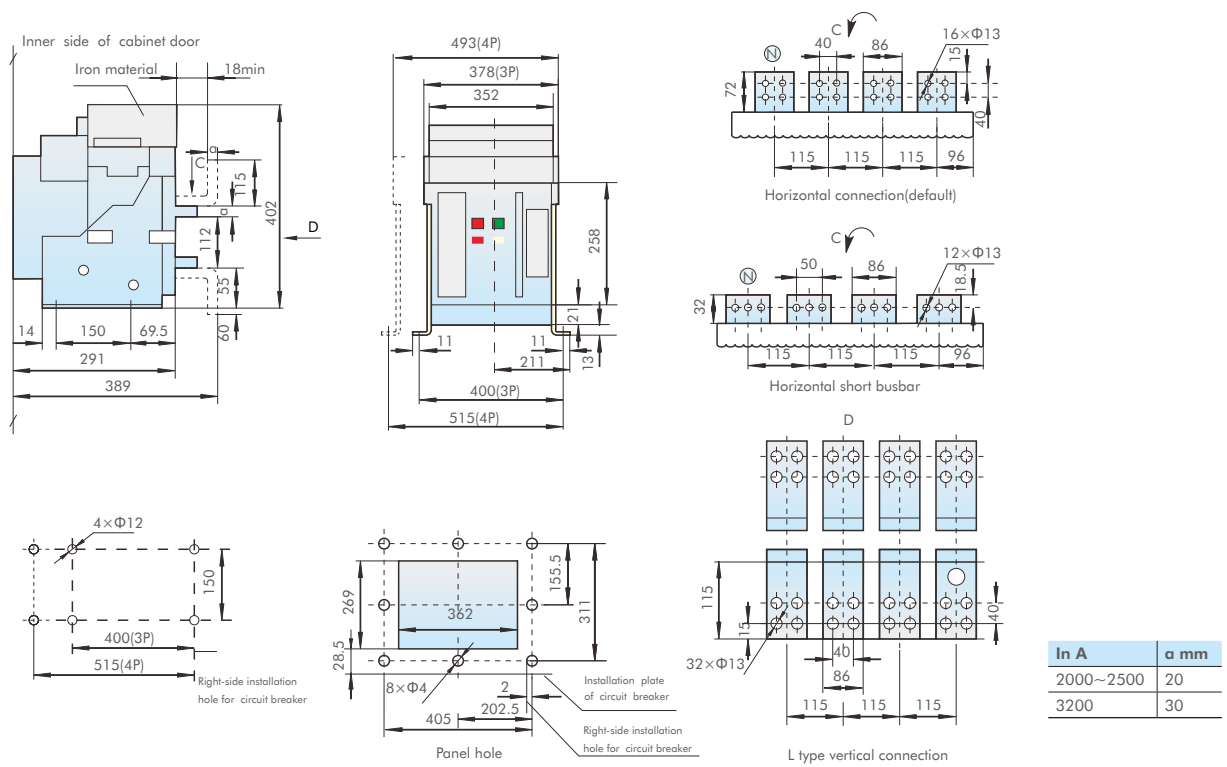

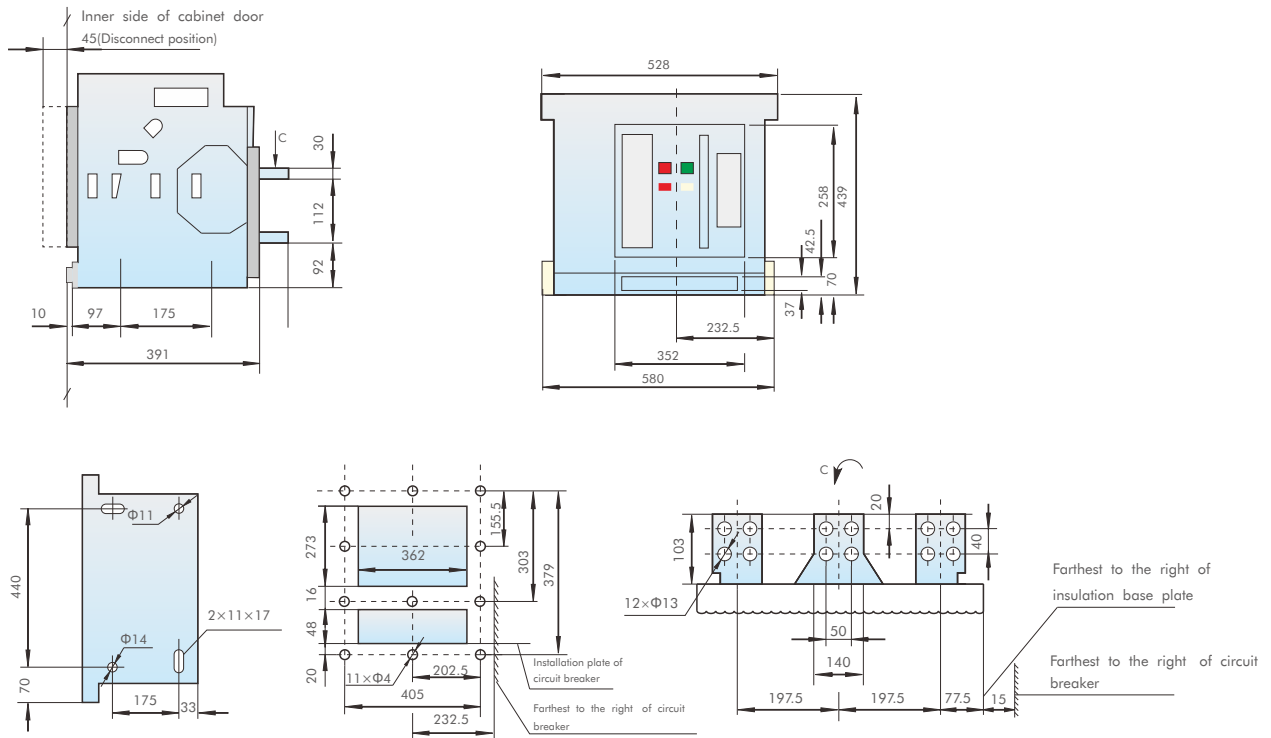
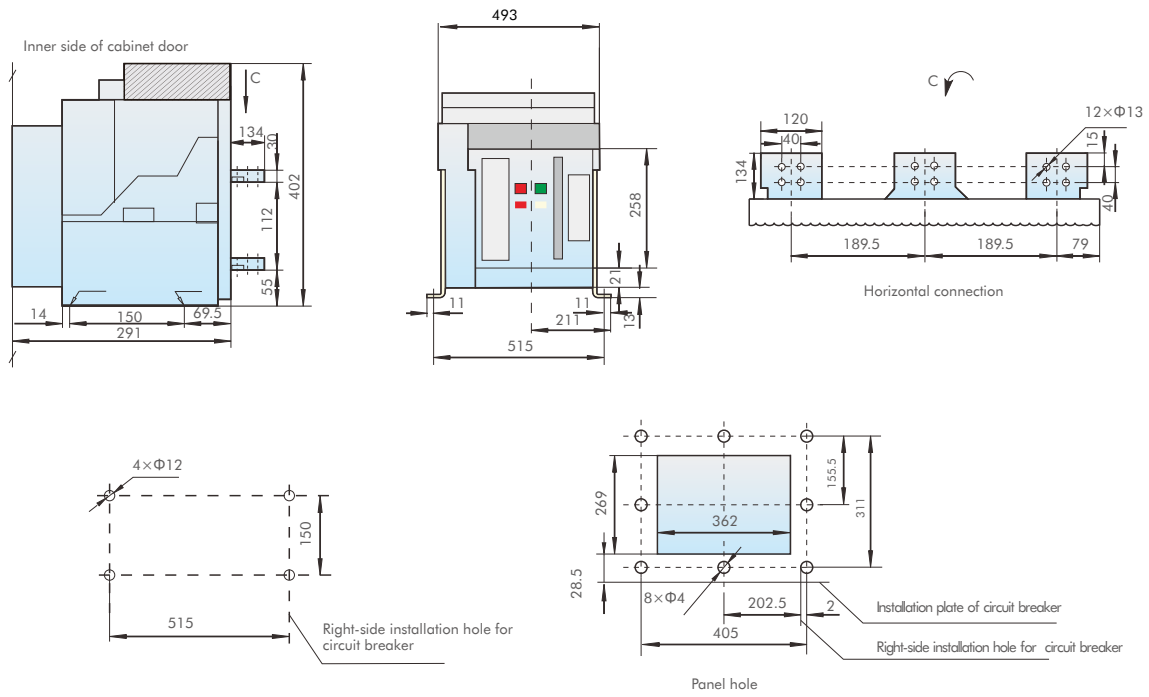

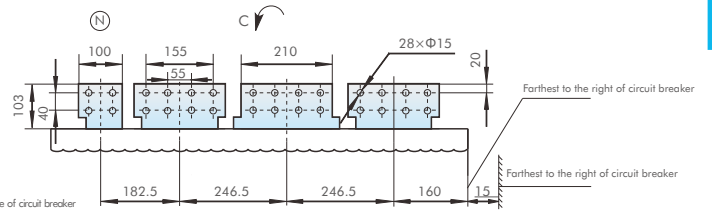
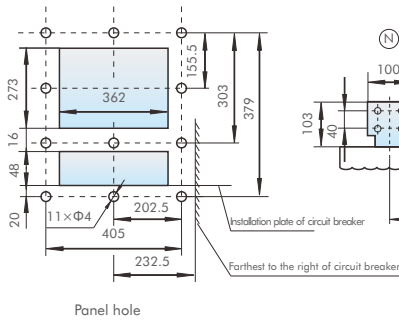
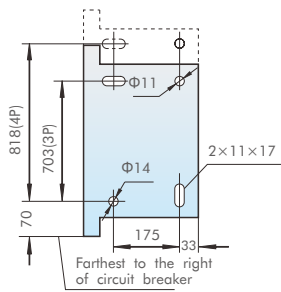
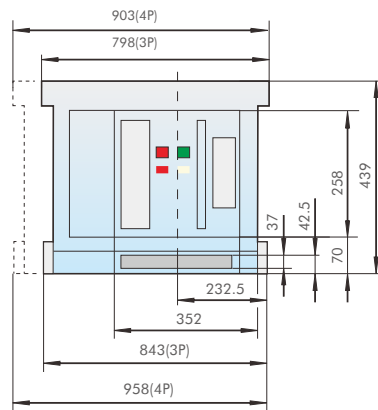
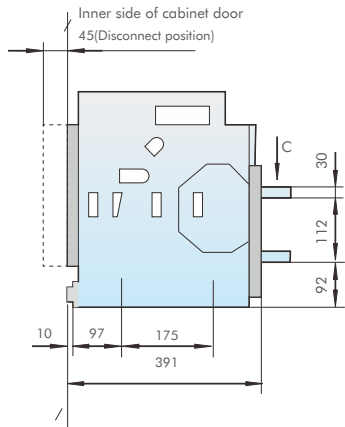



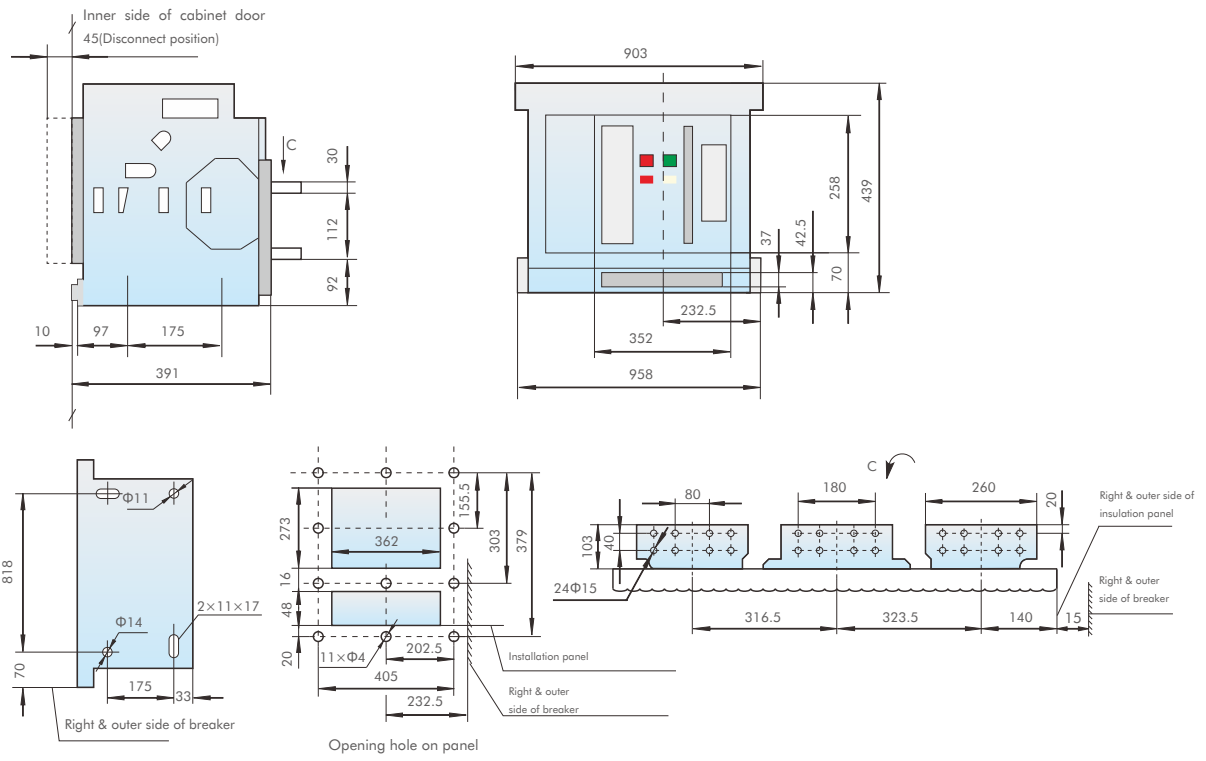

## 6.Secondary circuit wiring

### 6.1 NA1-1000X

Standard type, type (M/3M)

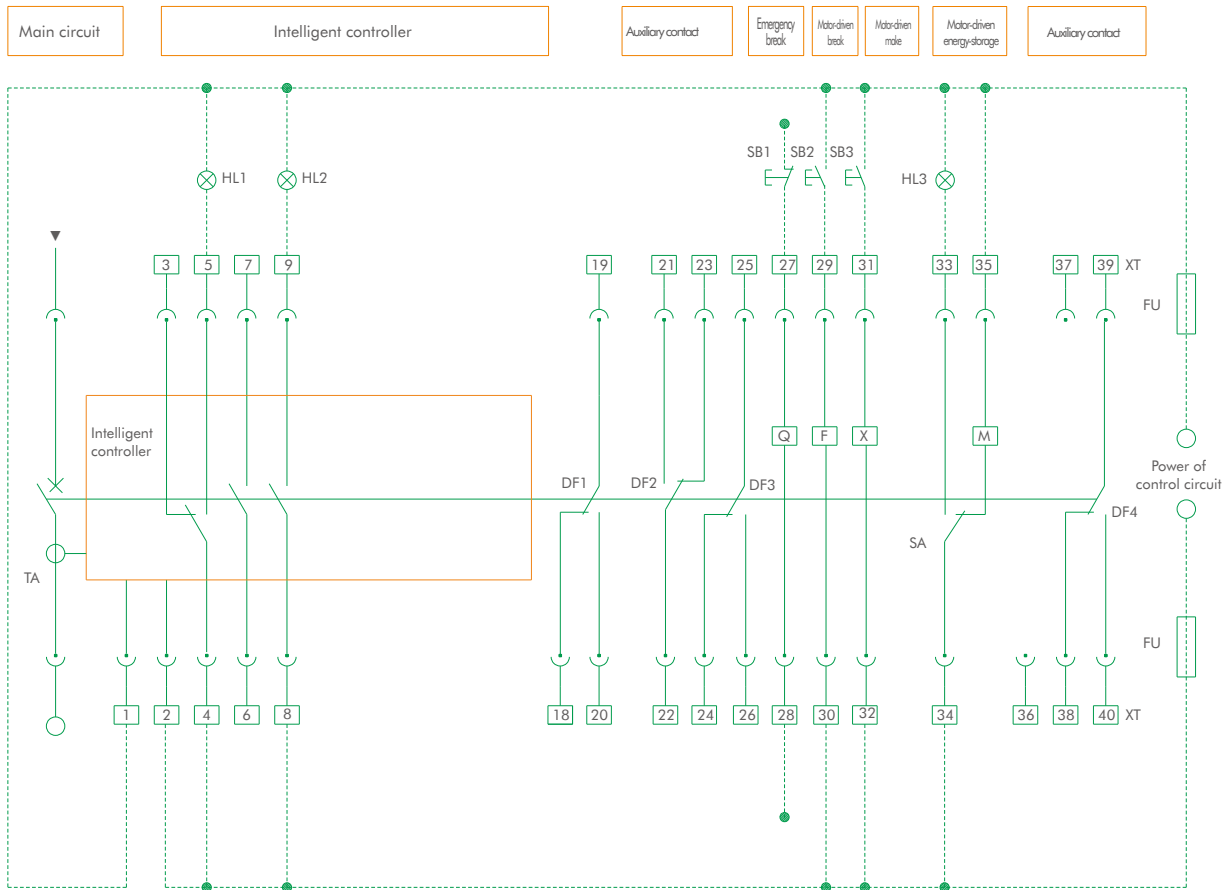

HL1: Failure indicator  
 HL2: Close indicator  
 HL3: Energy storage indicator  
 SB1: Under-voltage button  
 SB2: Shunt button  
 SB3: Close button  
 Q: Under-voltage release  
 F: Shunt release  
 X: Close electromagnet  
 M: Energy storage motor  
 DF1-DF4: Auxiliary switch  
 1<sup>#</sup>, 2<sup>#</sup>: Auxiliary power input  
 3<sup>#</sup>, 4<sup>#</sup>, 5<sup>#</sup>: Fault trip contact output(4<sup>#</sup> common terminal,  
 contact capacity AC230V,5A  
 6<sup>#</sup>, 7<sup>#</sup>: To be connected with current transformer(selective)

8<sup>#</sup>, 9<sup>#</sup>: Making indicator (capacity AC400V,1A)  
 27<sup>#</sup>, 28<sup>#</sup>: Under-voltage release(Connected to the main circuit)  
 29<sup>#</sup>, 30<sup>#</sup>: Shunt release  
 31<sup>#</sup>, 32<sup>#</sup>: Closing electromagnet  
 33<sup>#</sup>, 34<sup>#</sup>, 35<sup>#</sup>: Energy storage motor  
 18<sup>#</sup>~26<sup>#</sup>, 38<sup>#</sup>~40<sup>#</sup>: Auxiliary contact  
 (auxiliary contact capacity: AC230V,5A)

#### Note:

Dashed is to be connected by users.

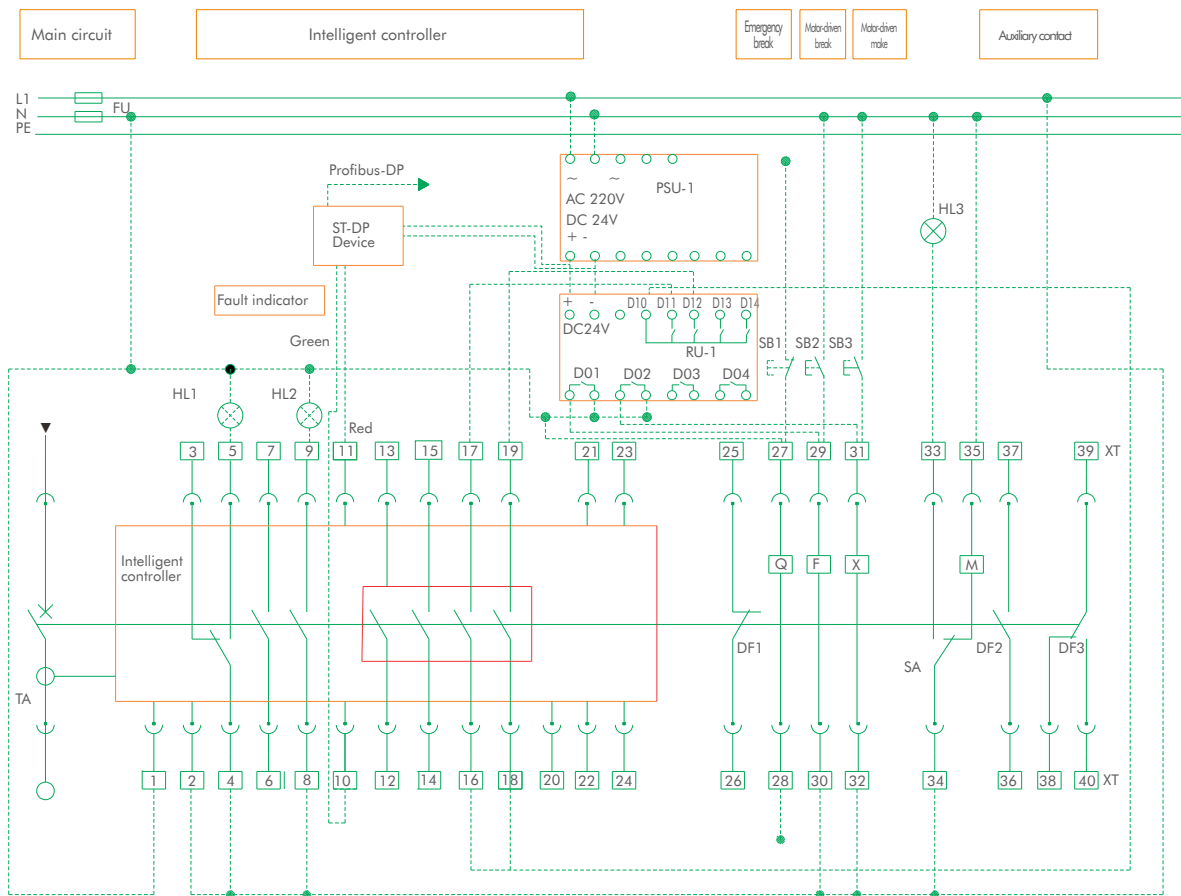

- HL1: Failure indicator
- HL2: Close indicator
- HL3: Energy storage indicator
- SB1: Under-voltage button
- SB2: Shunt button
- SB3: Close button
- Q: Under-voltage release
- F: Shunt release
- X: Close electromagnet
- M: Energy storage motor
- DF1-DF3: Auxiliary switch
- 1<sup>#</sup>, 2<sup>#</sup>: Auxiliary power input(DC24)
- 3<sup>#</sup>,4<sup>#</sup>,5<sup>#</sup>: Fault trip contact output(4<sup>#</sup> common terminal, contact capacity AC230V,5A
- 6<sup>#</sup>, 7<sup>#</sup>: To be connected with current transformer(N/O auxiliary contact, capacity AC400V, 1A,when no current transformer)

- 8<sup>#</sup>,9<sup>#</sup>: Making indicator(capacity AC400V,1A)
- 10<sup>#</sup>, 11<sup>#</sup>: communication output
- 12<sup>#</sup>, 13<sup>#</sup>: Signal alarm of load 1 output
- 14<sup>#</sup>, 15<sup>#</sup>: Signal alarm of load 2 output
- 16<sup>#</sup>, 17<sup>#</sup>: Making signal output
- 18<sup>#</sup>, 19<sup>#</sup>: Closing signal output
- 20<sup>#</sup>: Communication shield ground line
- 21<sup>#</sup>~24<sup>#</sup>: Voltage signal input of phase N,A,B,C (With voltage measurement); 21<sup>#</sup>~23<sup>#</sup> is a set of auxiliary switches (Without voltage measurement) 22<sup>#</sup>common terminal,contact capacity AC230V,5A
- 25<sup>#</sup>, 26<sup>#</sup>: Auxiliary contact (capacity:AC230V,5A)
- 27<sup>#</sup>,28<sup>#</sup>: Under-voltage release(Connected to the main circuit)
- 29<sup>#</sup>,30<sup>#</sup>: Shunt release
- 31<sup>#</sup>,32<sup>#</sup>: Closing electromagnet
- 33<sup>#</sup>,34<sup>#</sup>,35<sup>#</sup>: Energy storage motor
- 36<sup>#</sup>~40<sup>#</sup>: Auxiliary contact (capacity:AC230V,5A)

**Note:**

Dashed is to be connected by users.

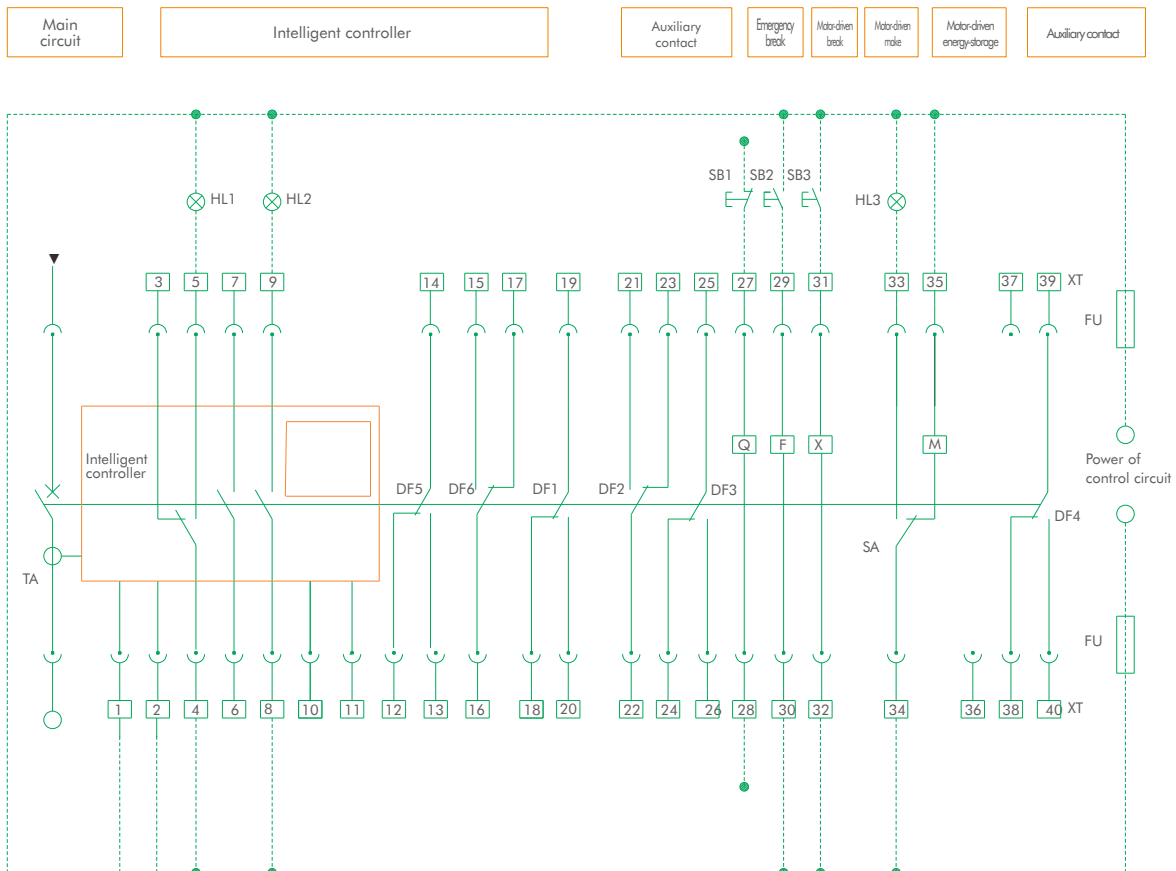

HL1: Failure indicator  
 HL2: Close indicator  
 HL3: Energy storage indicator

SB1: Under-voltage button  
 SB2: Shunt button  
 SB3: Close button

Q: Under-voltage release

F: Shunt release

X: Close release

M: Energy storage motor

DF1-DF6: Auxiliary switch

1<sup>#</sup>, 2<sup>#</sup>: Auxiliary power input

3<sup>#</sup>, 4<sup>#</sup>, 5<sup>#</sup>: Fault trip contact output(4<sup>#</sup> common terminal, contact capacity AC230V,5A

6<sup>#</sup>, 7<sup>#</sup>: to be connected with current transformer(selective)

8<sup>#</sup>, 9<sup>#</sup>: Making indicator (capacity AC400V,1A)

12<sup>#</sup>~26<sup>#</sup>: Auxiliary contact(auxiliary contact capacity: AC230V,1A)

27<sup>#</sup>, 28<sup>#</sup>: Under-voltage release(Connected to the main circuit)

29<sup>#</sup>, 30<sup>#</sup>: Shunt release

31<sup>#</sup>, 32<sup>#</sup>: Closing release

33<sup>#</sup>, 34<sup>#</sup>: Energy storage indicator

34<sup>#</sup>, 35<sup>#</sup>: Energy storage motor

38<sup>#</sup>~40<sup>#</sup>: Auxiliary contact(auxiliary contact capacity: AC230V,1A)

### Note:

Six pairs change-over contacts , without any additional function.

Dashed is to be connected by users.

6.2 NA1-2000X~6300X

The secondary circuit wiring for NA1-2000X~6300X with standard type (M) intelligent controller and instantaneous under-voltage release

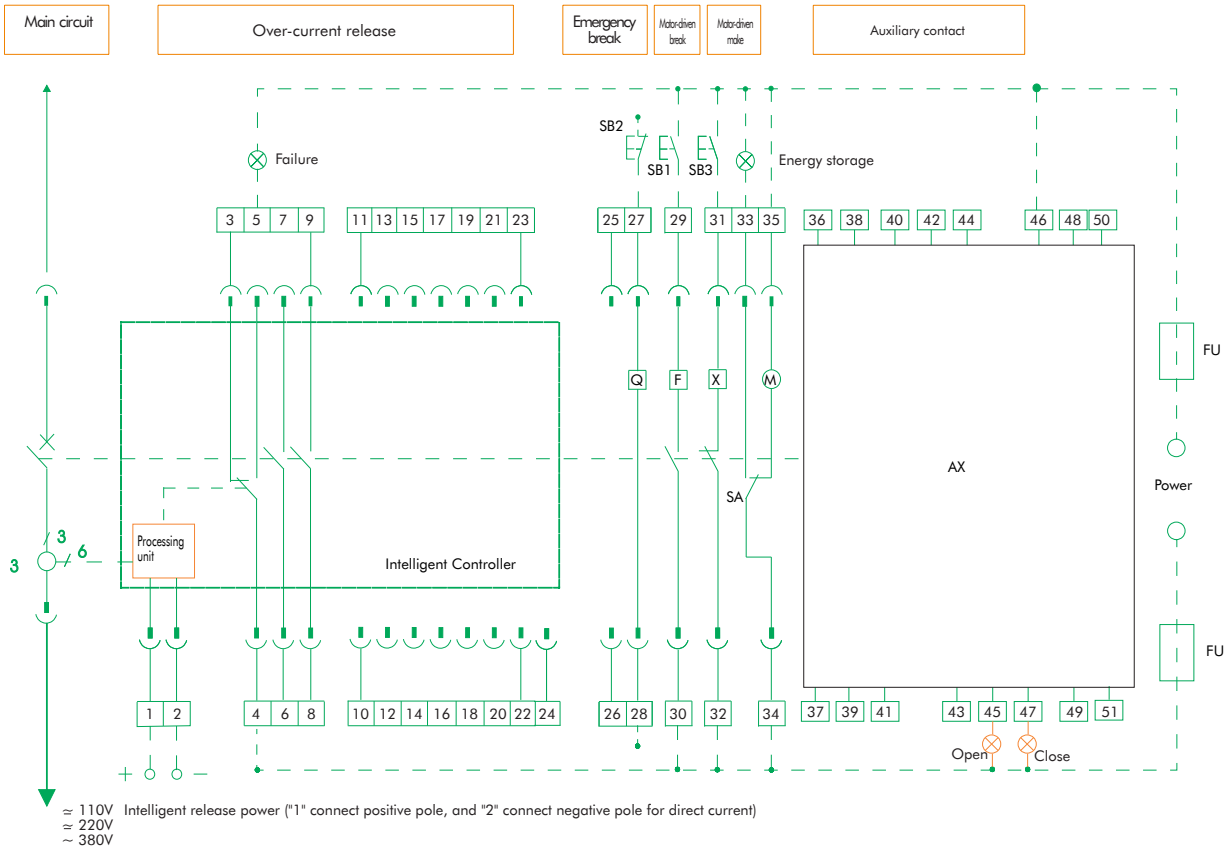

- SB1: Shunt button
  - SB2: Under-voltage button
  - SB3: Making button
  - Q: Under-voltage release
  - F: Shunt release
  - X: Closing electromagnet
  - M: Energy storage motor
  - XT: Connection terminal
  - SA: Position switch
- Note: If control voltage of Q, F, X is different from each other, they can be connected to different power.

The auxiliary contact modes for customer use

I Four pairs change-over contacts

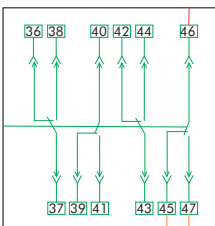

II Five pairs change-over contacts

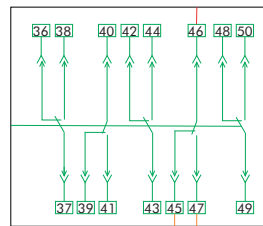

- 1<sup>#</sup>, 2<sup>#</sup>: Auxiliary power input
- 3<sup>#</sup>, 4<sup>#</sup>, 5<sup>#</sup>: Fault trip contact output(4<sup>#</sup> common terminal)
- 6<sup>#</sup>, 7<sup>#</sup>, 8<sup>#</sup>, 9<sup>#</sup>: Auxiliary contact, normal open,
- 10<sup>#</sup>~24<sup>#</sup>: empty
- 25<sup>#</sup>, 26<sup>#</sup>: to be connected with current transformer(selective)
- 27<sup>#</sup>, 28<sup>#</sup>: Under-voltage release(Connected to the main circuit)
- 29<sup>#</sup>, 30<sup>#</sup>: Shunt release
- 31<sup>#</sup>, 32<sup>#</sup>: Closing release
- 33<sup>#</sup>, 34<sup>#</sup>: Energy storage indicator
- 34<sup>#</sup>, 35<sup>#</sup>: Energy storage motor
- 36<sup>#</sup>, 51<sup>#</sup>: Auxiliary contact

Circuit explanation for signal output:

- a. Broken-line parts shall be provided by customers.
- b. Terminals 6<sup>#</sup>, 7<sup>#</sup> can output NC (normal close) contact if that is required by users.
- c. Terminal 35<sup>#</sup> can be directly connected to power (automatic pre-storing energy), alternatively connect power after connecting NO button (manual-controlled pre-storing energy).
- d. Terminals 21<sup>#</sup>~24<sup>#</sup> is only for wiring with function meter display. (excluding the special wiring)

The secondary circuit wiring for NA1-2000X~6300X with type (3M) intelligent controller and instantaneous under-voltage release

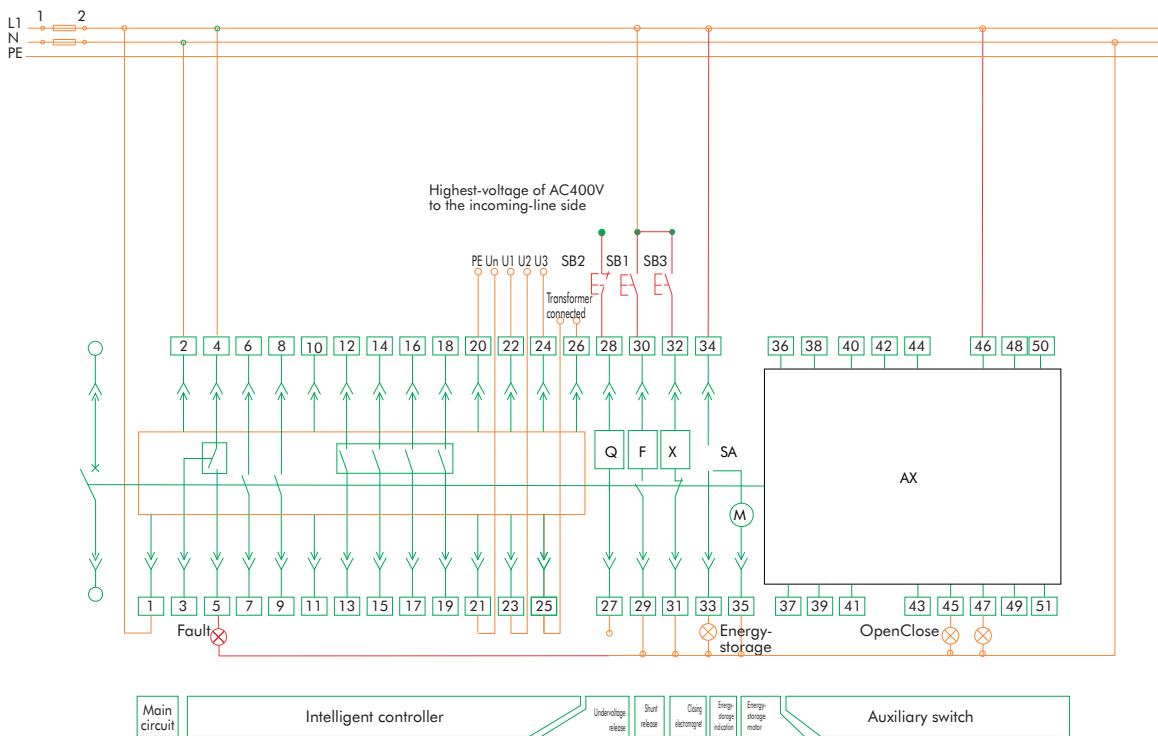

The auxiliary contact modes for customer use

I Four pairs change-over contacts

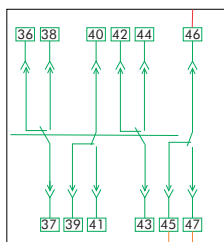

II Five pairs change-over contacts

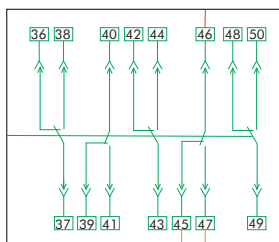

- SB1: Shunt button
- SB2: Under-voltage button
- SB3: Making button
- Q: Under-voltage release
- F: Shunt release
- X: Closing release
- M: Energy storage motor
- XT: connection terminal
- SA: Position switch

1<sup>#</sup>, 2<sup>#</sup>: Intelligent controller power input  
 Note: When the power supply of the intelligent controller is AC power, the 1<sup>#</sup>~2<sup>#</sup> connects to the AC power directly. When the power supply is DC power, forbid connecting the 1<sup>#</sup>~2<sup>#</sup> to the DC power directly. Add a DC power supply module, then the DC power connect to the input terminal of the DC power supply module, and the 1<sup>#</sup>~2<sup>#</sup> connect to the output terminal of the DC power supply module, or else the intelligent controller will be damaged.

3<sup>#</sup>,4<sup>#</sup>,5<sup>#</sup>: Fault trip contact output(4<sup>#</sup>common terminal)

6<sup>#</sup>,7<sup>#</sup>,8<sup>#</sup>,9<sup>#</sup>: Auxiliary contact(normal open)

10<sup>#</sup>~11<sup>#</sup>: empty

12<sup>#</sup>~19<sup>#</sup>: The programmable output terminal. The normal products without these terminals, but if the customer special ordered, the cost extra added.

3M type acquiescence output:

12<sup>#</sup>,13<sup>#</sup>: Signal alarm of load 1 output; 14<sup>#</sup>,15<sup>#</sup>: Signal alarm of load2 output

16<sup>#</sup>,17<sup>#</sup>: Self-diagnose alarm; 18<sup>#</sup>,19<sup>#</sup>: Fault trip; 20<sup>#</sup>: PE line; 21<sup>#</sup>~24<sup>#</sup>: Display the voltage of the signal input.

The normal products without these terminals,

if the customer special ordered the function meter, the cost extra added.

21<sup>#</sup>: N phase input terminal

22<sup>#</sup>,23<sup>#</sup>,24<sup>#</sup>: A, B, C three phase power input terminal (note the sequence)(highest-voltage of AC 400V)

25<sup>#</sup>,26<sup>#</sup>: Connect to the N phase current transformer or the input terminal of the current leakage transformer.

The normal products without these terminals, if the customer special ordered, the cost extra added.

27<sup>#</sup>,28<sup>#</sup>: Under-voltage release(Connected to the main circuit); 29<sup>#</sup>,30<sup>#</sup>: Shunt release; 31<sup>#</sup>,32<sup>#</sup>: Closing release;

33<sup>#</sup>,34<sup>#</sup>: Energy storage indicator; 34<sup>#</sup>,35<sup>#</sup>: Energy storage motor; 36<sup>#</sup>~51<sup>#</sup>: Auxiliary contact

**Note:**

a. Red colored part is to be connected by users

b. When the power system is three phase three wire, directly connect the Un to U2.

( If the voltage exceeds 400V, special explanation when ordered)

The secondary circuit wiring for NA1-2000X~6300X with type (3H) intelligent controller and instantaneous under-voltage release

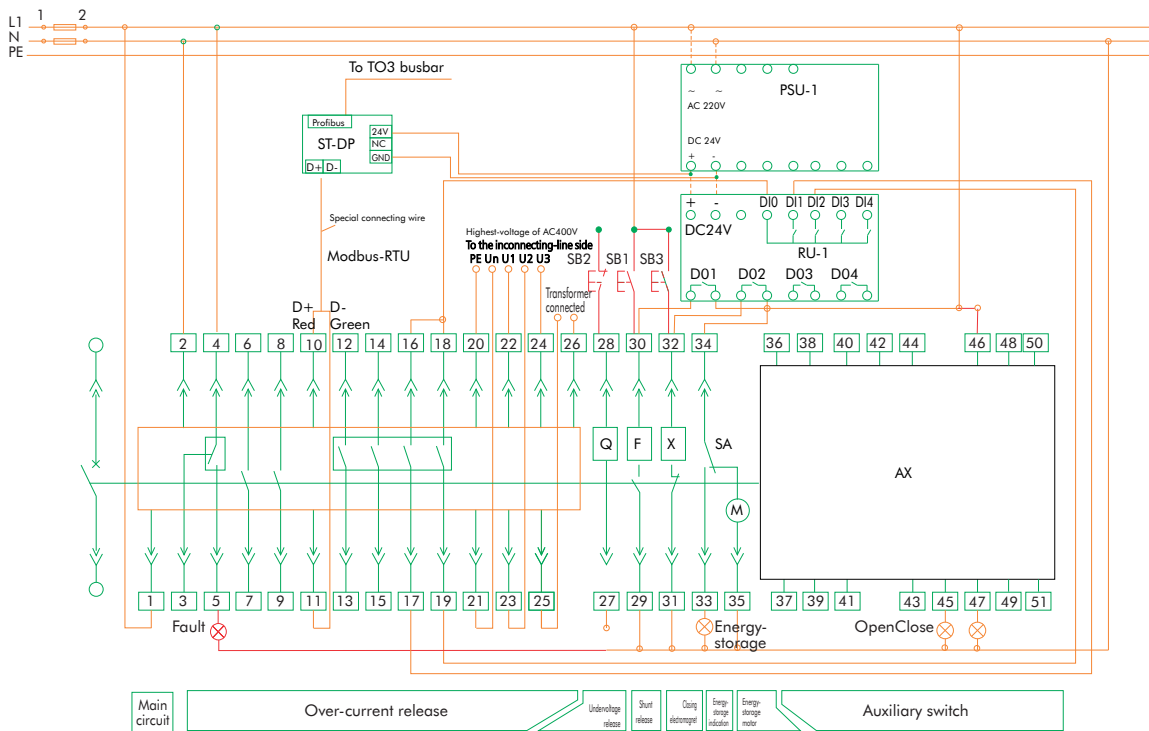

The auxiliary contact modes for customer use

I Four pairs change-over contacts

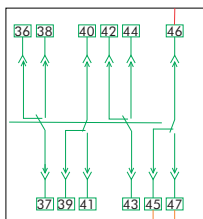

II Five pairs change-over contacts

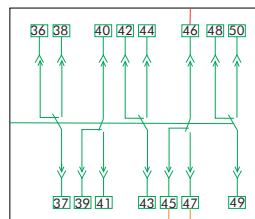

SB1: Shunt button; SB2: Under-voltage button  
 SB3: Making button; Q: Under-voltage release  
 F: Shunt release; X: Closing release  
 M: Energy storage motor; XT: connection terminal  
 SA: Position switch

1#, 2#: Intelligent controller power input  
 Note: When the power supply of the intelligent controller is AC power, the 1#~2# connects to the AC power directly. When the power supply is DC power, forbid connecting the 1#~2# to the DC power directly. Add a DC power supply module, then the DC power connect to the input terminal of the DC power supply module, and the 1#~2# connect to the output terminal of the DC power supply module, or else the intelligent controller will be damaged.

- 3#, 4#, 5#: Fault trip contact output (4# common terminal)
- 6#, 7#, 8#, 9#: Auxiliary contact (normal open)
- 10#~11#: communication output
- 12#, 13#: Signal alarm of load 1 output; 14#, 15#: Signal alarm of load<sup>2</sup> output
- 16#, 17#: Breaking signal output; 18#, 19#: Making signal output
- 20#: PE line; 21#: N phase input terminal
- 22#, 23#, 24#: A, B, C three phase power input terminal (note the sequence) (highest-voltage of AC 400V)

25#~26#: Connect to the N phase current transformer or the input terminal of the current leakage transformer. The normal products without these terminals, if the customer special ordered, the cost extra added.

ST~DP: DP protocol module. There is no need for the ST-DP protocol module, if the communication protocol is Modbus-RTV. But when the communication protocol is Profibus-DP, the ST-DP protocol module is necessary, but the cost extra added.

ST power module IV: power converter (optional components)

ST201: Magnify the signal capacity of the controller. ( optional components) If the customer special ordered, the cost extra added.

27#, 28#: Under-voltage release (Connected to the main circuit); 29#, 30#: Shunt release

31#, 32#: Closing release; 33#, 34#: Energy storage indicator

34#, 35#: Energy storage motor; 36#~51#: Auxiliary contact

### Note:

- a. Red colored part is to be connected by users
- b. When the power system is three phase three wire, directly connect the Un to U2. (If the voltage exceeds 400V, special explanation when ordered)

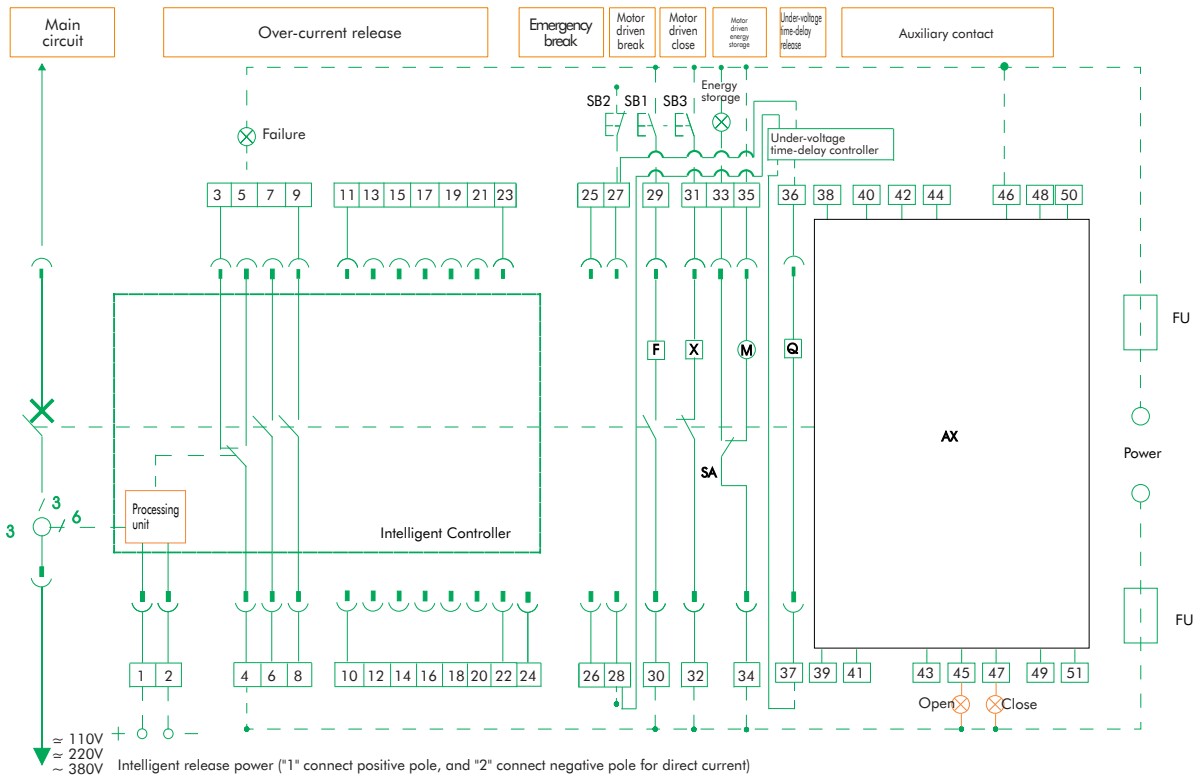

The auxiliary contact modes for customer use

I Four pairs change-over contacts

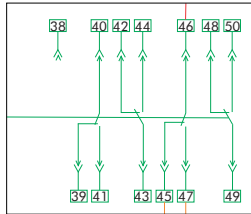

SB1: Shunt button SB2: Under-voltage button SB3: Making button  
 Q: Under-voltage time-delay release F: Shunt release  
 X: Closing electromagnet M: Energy storage motor  
 XT: Connection terminal SA: Position switch  
 Note: If control voltage of Q, F, X is different from each other, they can be connected to different power.

- 1#,2#: Auxiliary power input
- 3#,4#,5#: Fault trip contact output(4# common terminal)
- 6#,7#,8#,9#: Auxiliary contact (normal open)
- 10#~24#: empty
- 25#,26#: to be connected with current transformer(selective)
- 27#,28#: Under-voltage release(Connected to the main circuit)
- 29#,30#: Shunt release
- 31#,32#: Closing release
- 33#,34#: Energy storage indicator
- 34#,35#: Energy storage motor
- 36#,37#: Under-voltage time delay release
- 38#~51#: Auxiliary contact

Circuit explanation for signal output:

- a. Broken-line parts shall be provided by customers.
- b. Terminals 6#,7# can output NC (normal close) contact if that is required by users.
- c. Terminal 35# can be directly connected to power (automatic pre-storing energy), alternatively connect power after connecting NO button (manual-controlled pre-storing energy).
- d. The 21#~24# is only for wiring with function meter display. (Excluding the special wiring)



The secondary circuit wiring for NA1-2000X~6300X with type (3M) intelligent controller and time-delay under-voltage release

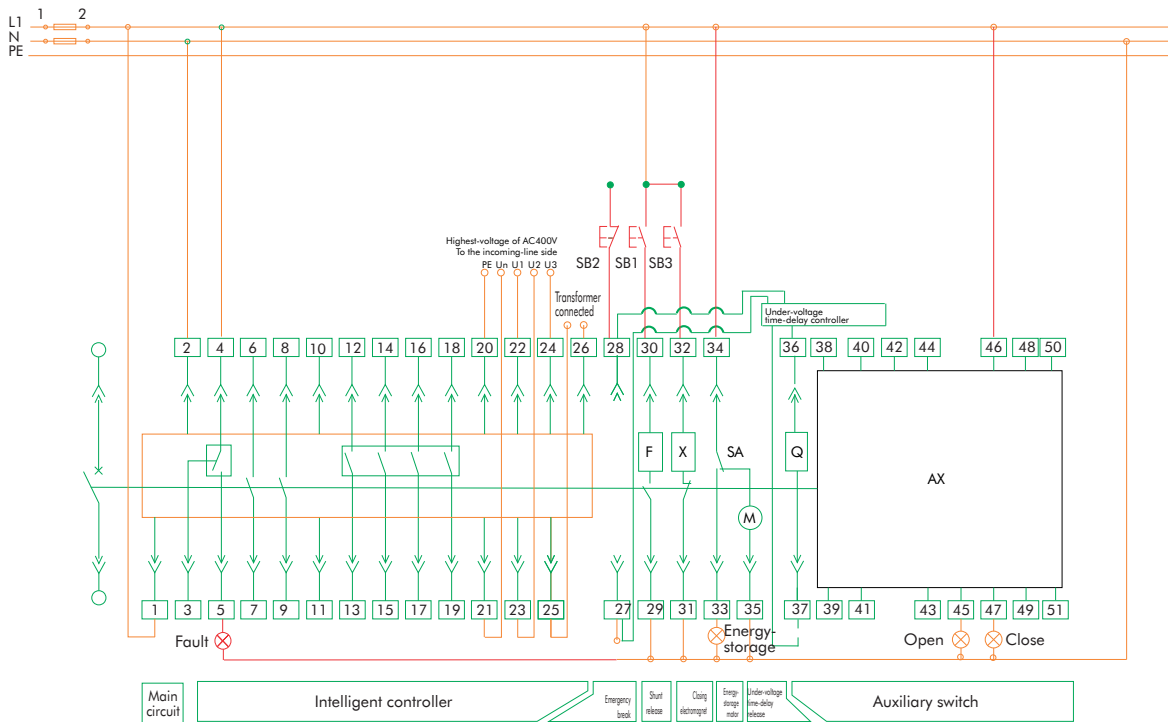

The auxiliary contact modes for customer use

I Four pairs change-over contacts

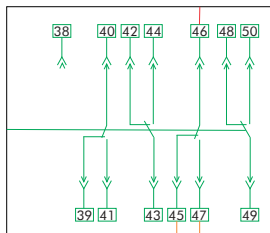

SB1: Shunt button; SB2: Under-voltage button  
 SB3: Making button; Q: Under-voltage release  
 F: Shunt release; X: Closing release  
 M: Energy storage motor; XT: Connection terminal  
 SA: Position switch  
 1#, 2#: Intelligent controller power input  
 Note: When the power supply of the intelligent controller is AC power, the 1#~2# connects to the AC power directly. When the power supply is DC power, forbid connecting the 1#~2# to the DC power directly. Add a DC power supply module, then the DC power connect to the input terminal of the DC power supply module, and the 1#~2# connect to the output terminal of the DC power supply module, or else the intelligent controller will be damaged.

3#,4#,5#: Fault trip contact output(4# common terminal);  
 6#,7#,8#,9#: Auxiliary contact (normal open)  
 10#~11#: empty; 12#~19# are the programmable output terminal. The normal products without these terminals, but if the customer special ordered, the cost extra added.

3M type acquiescence output:

12#,13#: Signal alarm of load 1 output; 14#,15#: Signal alarm of load2 output  
 16#,17#: Self-diagnose alarm; 18#,19#: Fault trip  
 20#: PE line; 21#~24#: Display the voltage of the signal input. The normal products without these terminals, if the customer special ordered the function meter, the cost extra added.  
 21#: N phase input terminal; 22#,23#,24#: A, B, C three phase power input terminal (note the sequence)(Highest-voltage of AC400V)

25#,26# Connect to the N phase current transformer or the input terminal of the current leakage transformer. The normal products without these terminals, if the customer special ordered, the cost extra added.  
 27#,28#: Under-voltage release(Connected to the main circuit); 29#,30#: Shunt release  
 31#,32#: Closing release; 33#,34#: Energy storage indicator  
 34#,35#: Energy storage motor; 36#,37#: Under-voltage time delay release  
 38#~51#: Auxiliary contact

**Note:**

- a. Red colored part is to be connected by users
- b. When the power system is three phase three wire, directly connect the Un to U2. (If the voltage exceeds 400V, special explanation when ordered)

The secondary circuit wiring for NA1-2000X~6300X with type (3H) intelligent controller and time-delay under-voltage release

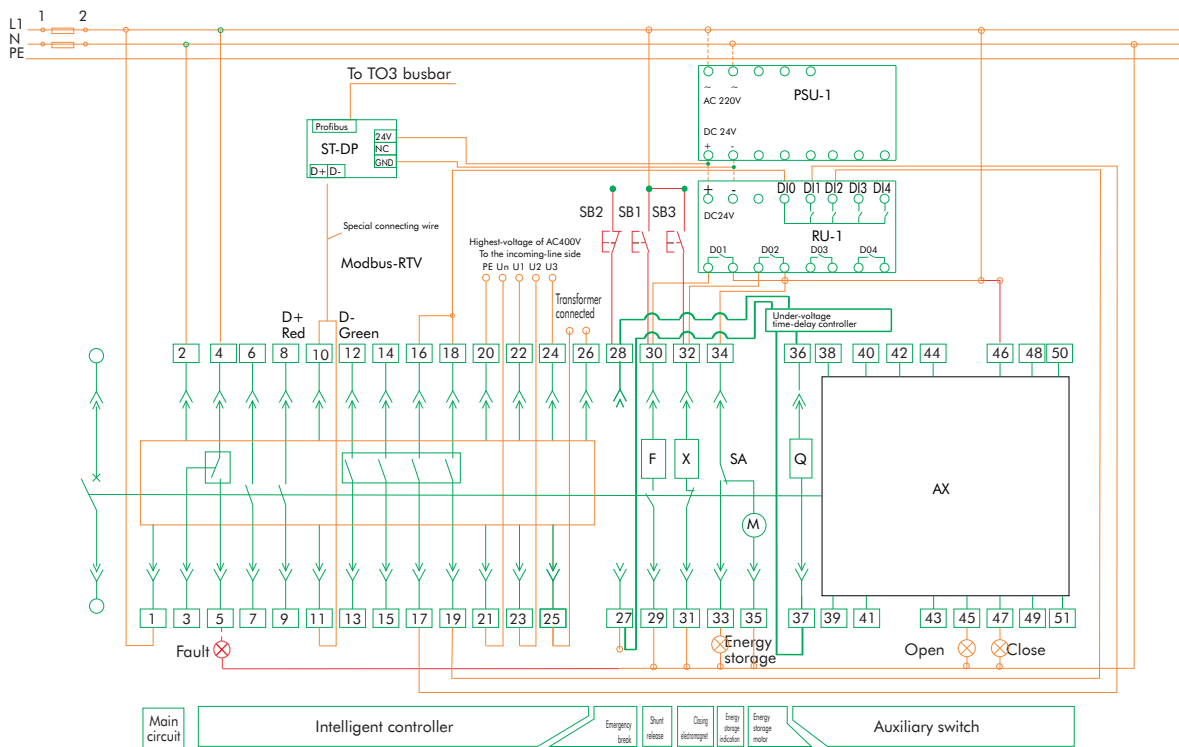

The auxiliary contact modes for customer use

I Four pairs change-over contacts

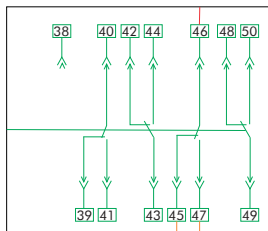

SB1: Shunt button; SB2: Under-voltage button  
 SB3: Making button; Q: Under-voltage release  
 F: Shunt release; X: Closing release  
 M: Energy storage motor; XT: Connection terminal  
 SA: Position switch  
 1<sup>#</sup>, 2<sup>#</sup>: Intelligent controller power input  
 Note: When the power supply of the intelligent controller is AC power, the 1<sup>#</sup>~2<sup>#</sup> connects to the AC power directly. When the power supply is DC power, forbid connecting the 1<sup>#</sup>~2<sup>#</sup> to the DC power directly. Add a DC power supply module, then the DC power connect to the input terminal of the DC power supply module, and the 1<sup>#</sup>~2<sup>#</sup> connect to the output terminal of the DC power supply module, or else the intelligent controller will be damaged.

3<sup>#</sup>,4<sup>#</sup>,5<sup>#</sup>: Fault trip contact output(4<sup>#</sup> common terminal)  
 6<sup>#</sup>,7<sup>#</sup>,8<sup>#</sup>,9<sup>#</sup>: Auxiliary contact (normal open)  
 10<sup>#</sup>~11<sup>#</sup>: Communication output; 12<sup>#</sup>,13<sup>#</sup>: Signal alarm of load 1 output  
 14<sup>#</sup>,15<sup>#</sup>: Signal alarm of load 2 output; 16<sup>#</sup>,17<sup>#</sup>: Breaking signal output; 18<sup>#</sup>,19<sup>#</sup>: Closing signal output  
 20<sup>#</sup>: PE line; 21<sup>#</sup>: N phase input terminal  
 22<sup>#</sup>,23<sup>#</sup>,24<sup>#</sup>: A, B, C three phase power input terminal (note the sequence)(highest-voltage of AC400V)  
 25<sup>#</sup>,26<sup>#</sup>: Connect to the N phase current transformer or the input terminal of the current leakage transformer.  
 The normal products without these terminals, if the customer special ordered, the cost extra added.  
 ST~DP: DP protocol module. There is no need for the ST-DP protocol module, if the communication protocol is Modbus-RTV. But when the communication protocol is Profibus-DP, the ST-DP protocol module is necessary, but the cost extra added.  
 ST power module IV: power converter (optional components)  
 ST201: Magnify the signal capacity of the controller. ( optional components)  
 If the customer special ordered, the cost extra added.  
 27<sup>#</sup>,28<sup>#</sup>: Under-voltage release(Connected to the main circuit); 29<sup>#</sup>,30<sup>#</sup>: Shunt release  
 31<sup>#</sup>,32<sup>#</sup>: Closing release; 33<sup>#</sup>,34<sup>#</sup>: Energy storage indicator  
 34<sup>#</sup>,35<sup>#</sup>: Energy storage motor; 36<sup>#</sup>,37<sup>#</sup>: Under-voltage time delay release  
 38<sup>#</sup>~51<sup>#</sup>: Auxiliary contact

**Note:**

- Red colored part is to be connected by users
- When the power system is three phase three wire, directly connect the Un to U2.  
(If the voltage exceeds 400V, special explanation when ordered)

## 7. Installation

### 7.1 Installation

7.1.1 Unload the breaker from the soleplate of package. If it is drawout type, firstly pull out the handle under the drawer-base of breaker, and plug it into the hole on central part of plastic cover under the drawer-base crossbeam, anticlockwise turns the handle, the body will slowly slide along the outside of drawer-base.

When the guide rod points to separated position and handle can't be rotated any longer, pull out the handle and firmly grasp the aluminum handle on drawer-base, pull out the breaker body and remove it from the base, then move the base from the sole plate and clean up the dirty things inside the drawer-base.

Possible positions

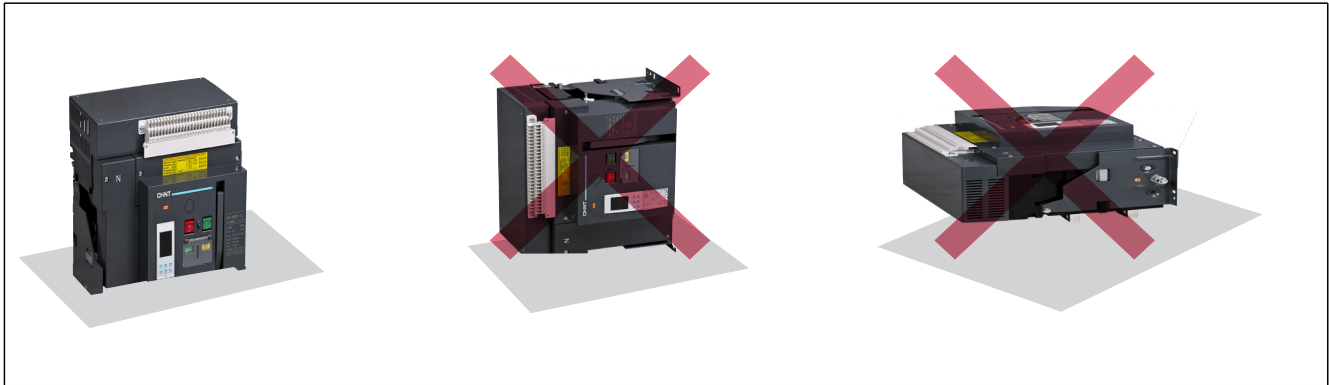

7.1.2 Check the insulation resistance with a 500V megger, resistance should not be less than  $20M\Omega$  when ambient temperature is  $20^{\circ}C \pm 5^{\circ}C$  and relative humidity is 50%~70%. Otherwise dry it.

7.1.3 Power supply  
NA1 devices can be supplied either from the top or from the bottom without reduction in performance, in order to facilitate connection when installed in a switchboard.



7.1.4 Put the breaker (fixed-type) or drawer-base (drawout-type) into the installation-bracket, and make it fixed, directly connect the cable wire of main circuit to the bus wire of fixed-type circuit breaker. Alternatively put breaker body onto the slideway of drawer-base. Plug the handle into installation hole, clockwise turns it until the under-part of drawer-base points at the connection position and "click" sound is heard. It indicates that breaker body has been connected to its place, then connect the cable of main circuit to drawer-base.

Mounting the circuit-breaker  
It is important to distribute the weight of the device uniformly over a rigid mounting surface such as rails or a base plate. This mounting plane should be perfectly flat (tolerance on support flatness: 2 mm). This eliminates any risk of deformation which could interfere with correct operation of the circuit breaker. NA1 devices can also be mounted on a vertical plane using the special brackets.



7.1.5 Partitions

Sufficient openings must be provided in partitions to ensure good air circulation around the circuit breaker; Any partition between upstream and downstream connections of the device must be made of nonmagnetic material. For high-currents, of 2500 A and upwards, the metal supports or barriers in the immediate vicinity of a conductor ;Metal barriers through which a conductor passes must not form a magnetic loop.

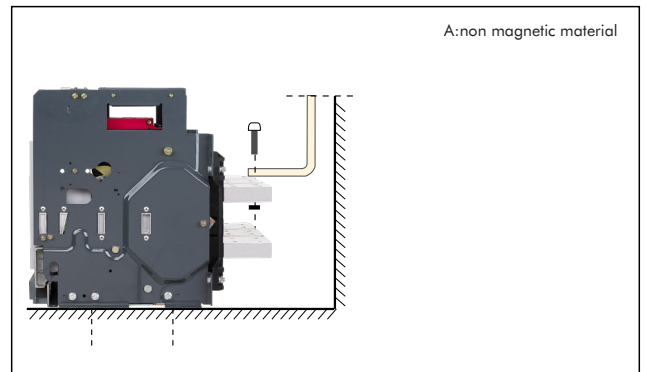

Busbars

The mechanical connection must be exclude the possibility of formation of a magnetic loop around a conductor.

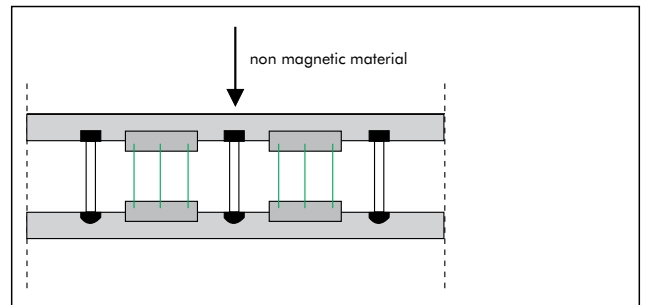

7.1.6 Busbar connections

The busbars should be suitably adjusted to ensure the connection points are positioned on the terminals before the bolts B are inserted. The connections are held by the supporter which is fixed to the framework of the switchboard, in this way the circuit breaker terminals do not have to support its weight C. (This support should be placed close to the terminals).

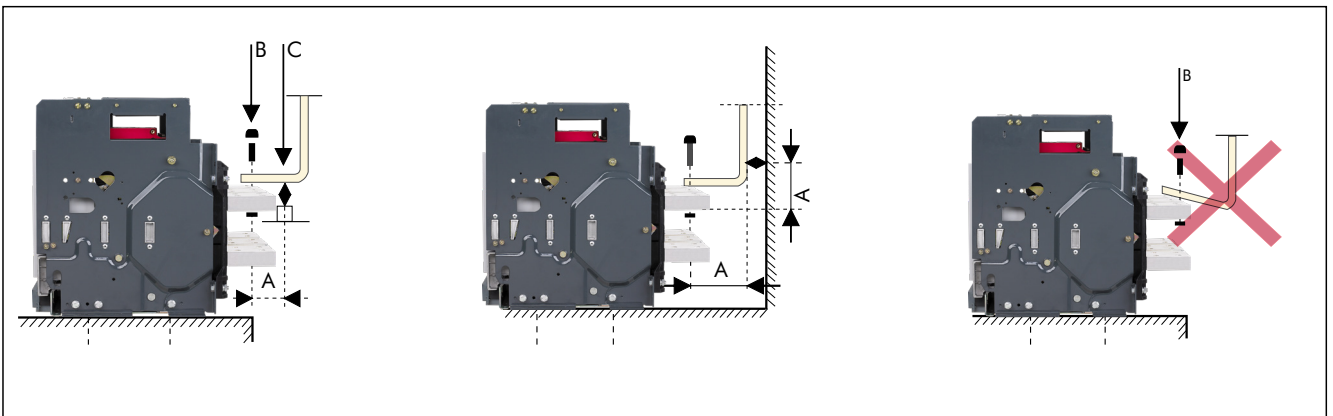

7.1.7 Main circuit adopts cable connection

Users should not apply too strong mechanical strength on the terminals of Air Circuit Breaker. Extend the bus-bar of circuit breaker with connecting bus-bar, position the wiring piece of cable before inserting bolts; the cable should be fixed on the frame of distributing cabinet firmly.

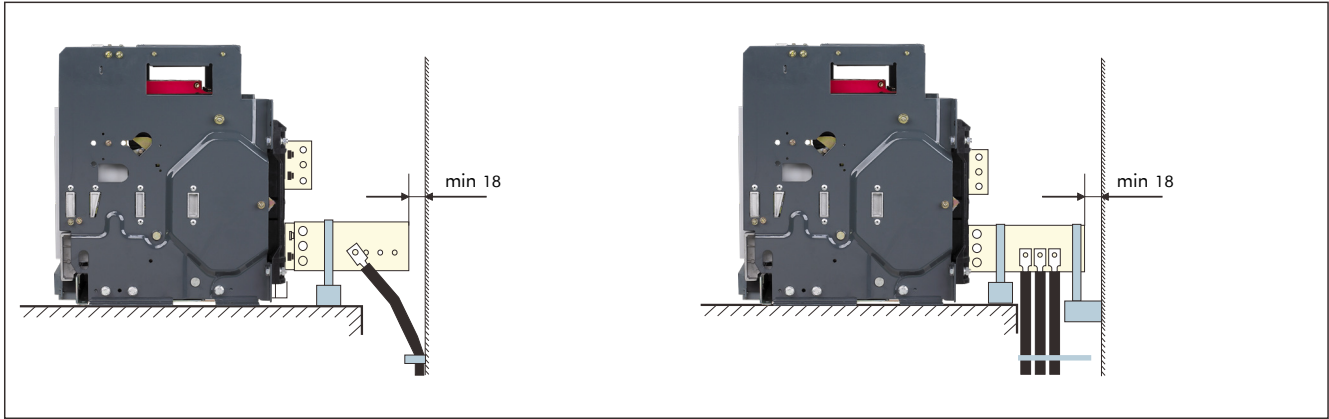

7.1.8 Clamping

Correct clamping of busbars depends on the tightening torques used for the nuts and bolts, etc. Over-tightening may have the same consequences as under-tightening.

For connecting busbars to the circuit breaker, the tightening torques to be used are shown in the table below. These values are for use with copper busbars and steel nuts and bolts, class  $\geq 8.8$ .

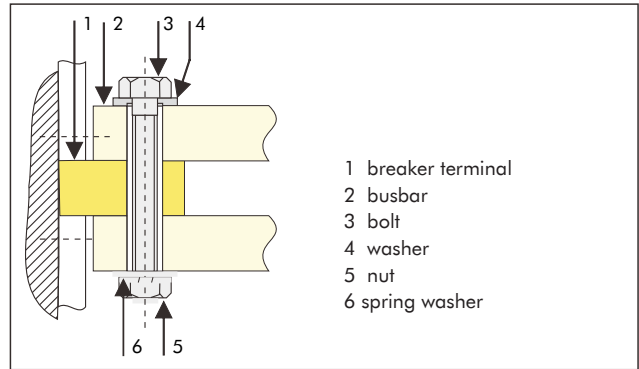

Examples

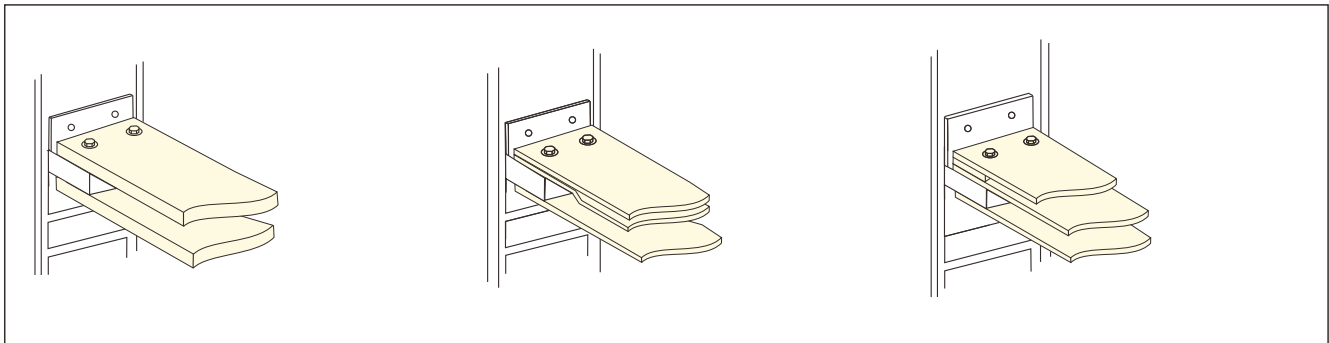

Preferred tightening torque for NA1's tightening components

Type of screw	Application	Preferred tightening torque
M3	Screws for secondary terminals	0.4~0.5 N·m
M10	Installing bolts of Air Circuit Breaker	38~55 N·m
M12	Connection terminals	61~94 N·m

Connected position



Test position

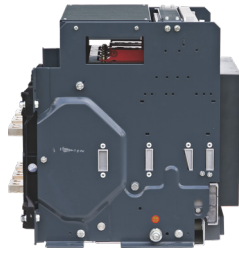

Disconnected position

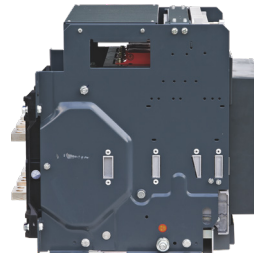

Drawout position

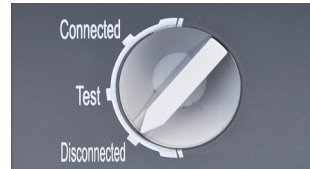
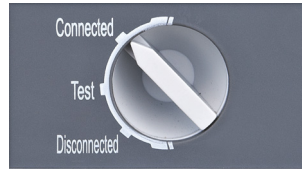
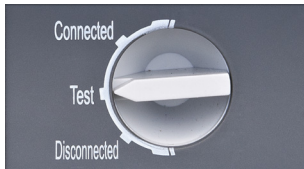
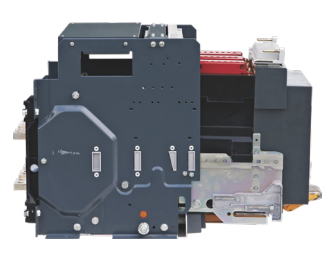

1. Both main circuit and control circuit are connected.  
2. Normal application conditions

1. The main circuit is disconnected, and the control circuit is connected.  
2. Test application conditions.

Neither the main circuit nor the control circuit is connected.

Main body is out of the drawer seat.

7.2 Wiring the secondary circuit according to electric principle diagram.  
Note: Bolts, nuts, gaskets shouldn't be left inside the drawer seat to avoid being blocked.

#### 7.3 Operation

Check the rated voltage of the following components whether conforms to the power voltage. Such as under voltage release, shunt release, closing electromagnet, motor-driven mechanism and intelligent controller.

#### 7.4 Maintenance

Check the technical parameters in time or add some lubricating oil, etc. This breaker structure is arranged vertically and modularized composition with each functioncell separated, which make the maintenance easy. It has compact structure, reliable operation and strong free maintenance capability. Please check the technical parameters on the nameplate in accordance with the requirements of order before installation.

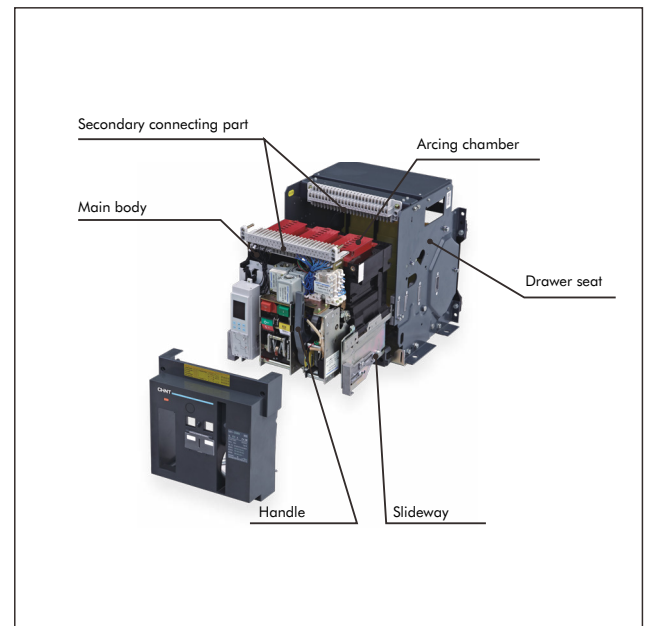

Making the secondary circuit power, the motor-driven mechanism can store energy automatically until hearing the click and energy stored indicating on the panel.

Otherwise press the storage handle for 6 times until hearing the click and the indicator display energy stored

And the closing operation can be realized either by closing electromagnet or manual button.

Manual energy-storage



Shake with the manual energy-storage handle up and down about six times to 'click'.

### 8. Recommendation for user's connecting bus-bar

Inm(A)		NA1-1000 X					NA1-2000X/NA1-2000XN/NA1-2000XH					NA1-3200X/NA1-3200XN			NA1-4000X		NA1-6300X/NA1-6300XN			
In(A)		200	400	630	800	1000	630	800	1000	1250	1600	2000	2000	2500	3200	4000/3P	4000/4P	4000	5000	6300
Busbar	Thickness(mm)	5	5	5	6	8	5	6	8	10	12	10	8	10	10	10	-	10	10	10
	Width(mm)	30	30	40	50	50	60	60	60	60	60	60	100	100	100	120	-	100	100	100
	Number	1	2	2	2	2	2	2	2	2	2	3	2	2	4	4	-	5	7	8

Note: the specifications in the table is obtained as the ambient temperature of air circuit breaker is 40°C , with open installation; this is in compliance with the specification of copper busbars adopted under the heating conditions regulated in IEC/EN60947-2.

### 9. Power loss

Inm(A)		NA1-1000 X					NA1-2000X/NA1-2000XN/NA1-2000XH					NA1-3200X/NA1-3200XN			NA1-4000X		NA1-6300X/NA1-6300XN			
In(A)		200	400	630	800	1000	630	800	1000	1250	1600	2000	2000	2500	3200	4000/3P	4000/4P	4000	5000	6300
Power loss (W)	Drawer type	40	101	123	110	171	70	110	172	268	440	530	384	600	737	921	-	575	898	1426
	Fixed type	33	85	107	94	146	34.4	50	78	122	200	262	200	312	307	450	-	-	-	-

### 10. A<sup>2</sup>S curve

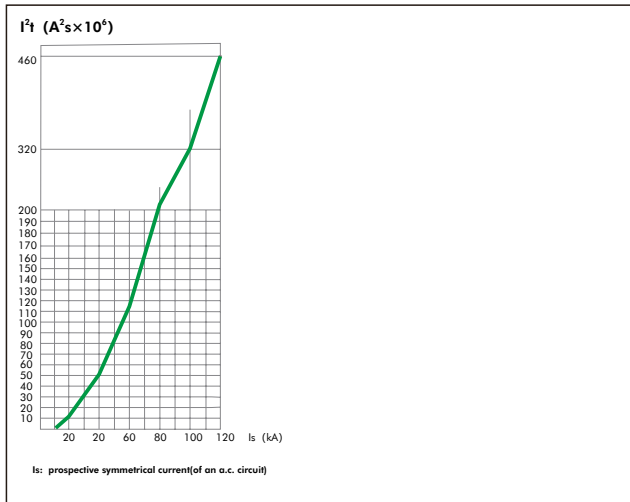

### 11. Temperature compensation correction

Standard	Ambient temperature	NA1-1000X					NA1-2000X/NA1-2000XN/NA1-2000XH					NA1-3200X/NA1-3200XN			NA1-4000X		NA1-6300X/NA1-6300XN		
		40°C	200	400	630	800	1000	630	800	1000	1250	1600	2000	2000	2500	3200	4000	4000	5000
IEC/EN60947-2	45°C	200	395	623	800	985	630	800	1000	1250	1600	2000	2000	2500	3200	3800	4000	5000	6000
	50°C	200	384	605	800	960	630	800	1000	1250	1600	2000	2000	2500	3200	3600	4000	5000	5600
	55°C	200	328	584	800	924	630	800	1000	1250	1500	1900	2000	2300	3000	3400	4000	4800	5400
	60°C	200	248	548	800	870	610	800	1000	1250	1300	1800	2000	2200	2800	3200	4000	4800	5200
	65°C	192	192	500	800	810	610	800	1000	1250	1300	1650	2000	2200	2600	3000	4000	4600	5100
	70°C	170	170	473	750	750	473	800	1000	1200	1200	1400	2000	2000	2200	2520	4000	4000	4200

Note: The ACB is to calibrated at 40°C , special application please refer to the table above and the curve below.

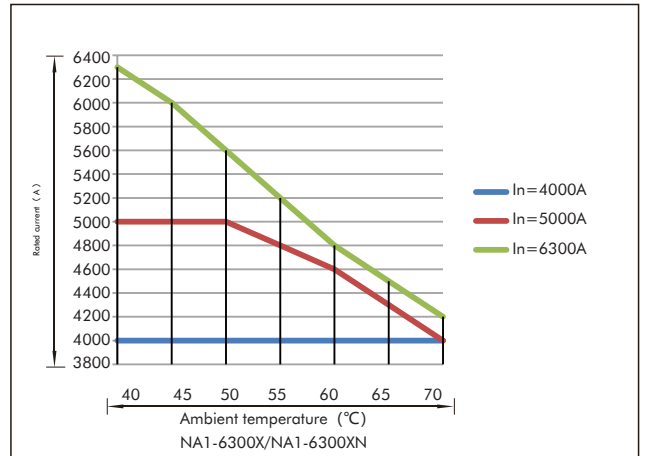
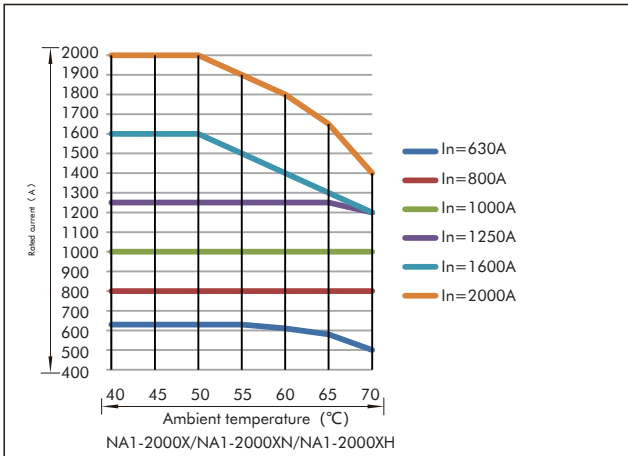
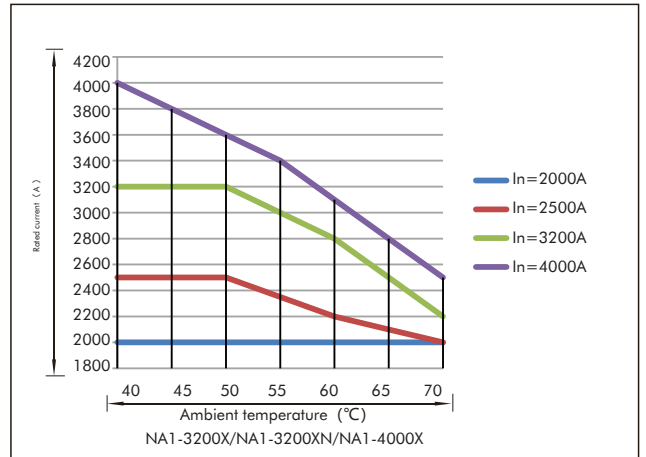
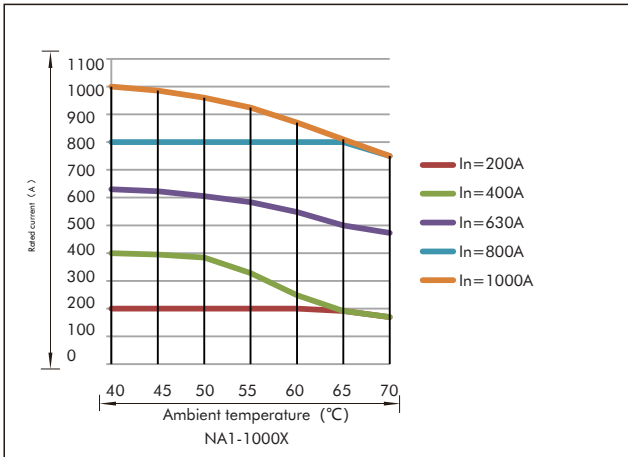



## 12. Coordination recommendations

Capacity of transformer (kVA) & parallelly connected number	Rated current of transformer In(A)	Short circuit current of main circuit (kA)	Breaking capacity of air circuit breaker for main circuit (kA)
1×250	360	9	9
2×250	360	9	9
3×250	360	9	18.5
1×315	455	11.4	11.4
2×315	455	11.4	11.4
3×315	455	11.4	22.7
1×400	578	14.4	14.4
2×400	578	14.4	14.4
3×400	578	14.4	28.8
1×500	722	18	18
2×500	722	18	18
3×500	722	18	36.1
1×630	910	22.7	22.7
2×630	910	22.7	22.7
3×630	910	22.7	44.5
1×800	1154	19.3	19.3
2×800	1154	19.3	19.3
3×800	1154	19.3	38.5
1×1000	1444	24	24
3×1000	1444	24	24
3×1000	1444	24	48.1
1×1250	1805	30	30
2×1250	1805	30	30
3×1250	1805	30	60.1
1×1600	2310	36.5	36.5
2×1600	2310	36.5	36.5
3×1600	2310	36.5	73
1×2000	2887	48.2	48.2
2×2000	2887	48.2	48.2
3×2000	2887	48.2	96.3
1×2500	3608	60	60
2×2500	3608	60	60
1×3150	4550	75.8	75.8
2×3150	4550	75.8	75.8

Type of air circuit breaker for main circuit	Number and area of the busbar for main circuit (n×W×T)	Breaking capacity of air circuit breaker for branch circuit (kA)	Air circuit breaker for branch circuit
NA1-1000X-400		9	
NA1-1000X-400	2×(5×30)	18.5	NA1, NM8
NA1-1000X-400		27.5	
NA1-1000X-630		11.4	
NA1-1000X-630	2×(5×40)	22.7	NA1, NM8
NA1-1000X-630		34.1	
NA1-1000X-630		14.4	
NA1-1000X-630	2×(5×40)	28.8	NA1, NM8
NA1-1000X-630		43.2	
NA1-1000X-800		18	
NA1-1000X-800	2×(6×50)	36.1	NA1, NM8
NA1-1000X-800		54.1	
NA1-1000X-1000		22.7	
NA1-1000X-1000	2×(8×50)	44.5	NA1, NM8
NA1-1000X-1000		67.2	
NA1-2000X-1250		19.3	
NA1-2000X-1250	2×(10×60)	38.5	NA1, NM8
NA1-2000X-1250		57.8	
NA1-2000X-1600		24	
NA1-2000X-1600	2×(12×60)	48.1	NA1, NM8
NA1-2000X-1600		72.1	
NA1-2000X-2000		30	
NA1-2000X-2000	3×(10×60)	60.1	NA1, NM8
NA1-2000X-2000		90.1	
NA1-3200X-2500		36.5	
NA1-3200X-2500	2×(10×100)	73	NA1, NM8
NA1-3200X-2500		109.5	
NA1-3200X-3200		48.2	
NA1-3200X-3200	4×(10×100)	96.3	NA1, NM8
NA1-3200X-3200		144.5	
NA1-6300X-4000	4×(10×120)	60	NA1, NM8
NA1-6300X-4000		120	
NA1-6300X-5000		75.8	
NA1-6300X-5000	7×(10×100)	151.6	NA1, NM8

### 13. Selectivity protection

#### 13.1 Selective protection between NM8 and NA1

			Circuit breaker	NA1-2000X/NA1-2000XN/NA1-2000XH			
Downstream	Upstream	Rated current (A)	630	800	1000	1250	
		Default setting ratings of short time-delay 8In (kA)	5.04	6.4	8	10	
		Setting range (kA)	0.63 ~ 9.45	0.8~12	1~15	1.25~18.75	
		Delayed tripping time (s)	0.1, 0.2, 0.3, 0.4				
		Returnable time	0.06, 0.14, 0.23, 0.35				
Frame size rated current	Rated current (A)	Instantaneous setting ratings (kA)					
NM8-125 NM8S-125	16	0.16 0.19(motor)	0.63~9.45 0.63~9.45	0.8~12 0.8~12	1~15 1~15	1.25~18.75 1.25~18.75	
	20	0.2 0.24(motor)	0.63~9.45 0.63~9.45	0.8~12 0.8~12	1~15 1~15	1.25~18.75 1.25~18.75	
	25	0.25 0.30(motor)	0.63~9.45 0.63~9.45	0.8~12 0.8~12	1~15 1~15	1.25~18.75 1.25~18.75	
	32	0.32 0.38(motor)	0.63~9.45 0.63~9.45	0.8~12 0.8~12	1~15 1~15	1.25~18.75 1.25~18.75	
	40	0.40 0.48(motor)	0.63~9.45 0.6624~9.45	0.8~12 0.8~12	1~15 1~15	1.25~18.75 1.25~18.75	
	50	0.50 0.60(motor)	0.69~9.45 0.828~9.45	0.8~12 0.828~12	1~15 1~15	1.25~18.75 1.25~18.75	
	63	0.63 0.75(motor)	0.8694~9.45 1.035~9.45	0.8694~12 1.035~12	1~15 1.035~15	1.25~18.75 1.25~18.75	
	80	0.80 0.96(motor)	1.104~9.45 1.325~9.45	1.104~12 1.325~12	1.104~15 1.325~15	1.25~18.75 1.325~18.75	
	100	1.0 1.20(motor)	1.38~9.45 1.656~9.45	1.38~12 1.656~12	1.38~15 1.656~15	1.38~18.75 1.656~18.75	
	125	1.25 1.5(motor)	1.725~9.45 2.07~9.45	1.725~12 2.07~12	1.725~15 2.07~15	1.725~18.75 2.07~18.75	
NM8-250 NM8S-250	100	1.0 1.2(motor)	1.38~9.45 1.656~9.45	1.38~12 1.656~12	1.38~15 1.656~15	1.38~18.75 1.656~18.75	
	160	1.6 1.92(motor)	2.208~9.45 2.65~9.45	2.208~12 2.65~12	2.208~15 2.65~15	2.208~18.75 2.65~18.75	
	200	2.0 2.4(motor)	2.76~9.45 3.312~9.45	2.76~12 3.312~12	2.76~15 3.312~15	2.76~18.75 3.312~18.75	
	250	2.5 3.0(motor)	3.45~9.45 4.14~9.45	3.45~12 4.14~12	3.45~15 4.14~15	3.45~18.75 4.14~18.75	



			Circuit breaker	NA1-2000X/NA1-2000XN/NA1-2000XH					
Downstream		Upstream	Rated current (A)	630	800	1000	1250		
			Default setting ratings of short time-delay 8In (kA)	5.04	6.4	8	10		
			Setting range (kA)	0.63 ~ 9.45	0.8~12	1~15	1.25~18.75		
			Delayed tripping time (s)	0.1, 0.2, 0.3, 0.4					
			Returnable time	0.06, 0.14, 0.23, 0.35					
Frame size rated current	Rated current (A)	Instantaneous setting ratings (kA)							
NM8-630 NM8S-630	250	2.5 3.0(motor)			3.45~9.45 4.14~9.45	3.45~12 4.14~12	3.45~15 4.14~15	3.45~18.75 4.14~18.75	
	315	3.15 3.78(motor)			4.347~9.45 5.216~9.45	4.347~12 5.216~12	4.347~15 5.216~15	4.347~18.75 5.216~18.75	
	350	3.5 4.2(motor)			4.83~9.45 5.796~9.45	4.83~12 5.796~12	4.83~15 5.796~15	4.83~18.75 5.796~18.75	
	400	4.0 4.8(motor)			5.52~9.45 6.624~9.45	5.52~12 6.624~12	5.52~15 6.624~15	5.52~18.75 6.624~18.75	
	500	5.0 6.0(motor)			6.9~9.45 8.28~9.45	6.9~12 8.28~12	6.9~15 8.28~15	6.9~18.75 8.28~18.75	
NM8S-630	630	6.3 7.56(motor)			8.694~9.45	8.694~12 10.44~12	8.694~15 10.44~15	8.694~18.75 10.44~18.75	
	630	6.3 7.56(motor)			8.694~9.45	8.694~12 10.44~12	8.694~15 10.44~15	8.694~18.75 10.44~18.75	
	700	7.0 8.4(motor)				9.66~12 11.59~12	9.66~15 11.59~15	9.66~18.75 11.59~18.75	
NM8-1250 NM8S-1250	800	8.0 9.6(motor)				11.04~12	11.04~15 13.25~15	11.04~18.75 13.25~18.75	
	1000	10 12(motor)					13.8~15	13.8~18.75 16.56~18.75	
	1250	12.5 15.0(motor)						17.25~18.75	

		NA1-3200X/NA1-3200XN				NA1-4000X	NA1-6300X/NA1-6300XN		
	1600	2000	2000	2500	3200	4000	4000	5000	6300
	12.8	16	16	20	25.6	32	32	40	50.4
	1.6~24	2~30	2~30	2.5~37.7	3.2~48	4~60	4~60	5~75	6.3~94.5
0.1, 0.2, 0.3, 0.4									
0.06, 0.14, 0.23, 0.35									
	3.45~24 4.14~24	3.45~30 4.14~30	3.45~30 4.14~30	3.45~37.7 4.14~37.7	3.45~48 4.14~48	3.45~60 4.14~60	3.45~60 4.14~60	3.45~75 4.14~75	3.45~94.5 4.14~94.5
	4.347~24 5.216~24	4.347~30 5.216~30	4.347~30 5.216~30	4.347~37.7 5.216~37.7	4.347~48 5.216~48	4.347~60 5.216~60	4.347~60 5.216~60	4.347~75 5.216~75	4.347~94.5 5.216~94.5
	4.83~24 5.796~24	4.83~30 5.796~30	4.83~30 5.796~30	4.83~37.7 5.796~37.7	4.83~48 5.796~48	4.83~60 5.796~60	4.83~60 5.796~60	4.83~75 5.796~75	4.83~94.5 5.796~94.5
	5.52~24 6.624~24	5.52~30 6.624~30	5.52~30 6.624~30	5.52~37.7 6.624~37.7	5.52~48 6.624~48	5.52~60 6.624~60	5.52~60 6.624~60	5.52~75 6.624~75	5.52~94.5 6.624~94.5
	6.9~24 8.28~24	6.9~30 8.28~30	6.9~30 8.28~30	6.9~37.7 8.28~37.7	6.9~48 8.28~48	6.9~60 8.28~60	6.9~60 8.28~60	6.9~75 8.28~75	6.9~94.5 8.28~94.5
	8.694~24 10.44~24	8.694~30 10.44~30	8.694~30 10.44~30	8.694~37.7 10.44~37.7	8.694~48 10.44~48	8.694~60 10.44~60	8.694~60 10.44~60	8.694~75 10.44~75	8.694~94.5 10.44~94.5
	8.694~24 10.44~24	8.694~30 10.44~30	8.694~30 10.44~30	8.694~37.7 10.44~37.7	8.694~48 10.44~48	8.694~60 10.44~60	8.694~60 10.44~48	8.694~75 10.44~75	8.694~94.5 10.44~94.5
	9.66~24 11.59~24	9.66~30 11.59~30	9.66~30 11.59~30	9.66~37.7 11.59~37.7	9.66~48 11.59~48	9.66~60 11.59~60	9.66~48 11.59~60	9.66~75 11.59~75	9.66~94.5 11.59~94.5
	11.04~24 13.25~24	11.04~30 13.25~30	11.04~30 13.25~30	11.04~37.7 13.25~37.7	11.04~48 13.25~48	11.04~60 13.25~60	11.04~60 13.25~60	11.04~75 13.25~75	11.04~94.5 13.25~94.5
	13.8~24 16.56~24	13.8~30 16.56~30	13.8~30 16.56~30	13.8~37.7 16.56~37.7	13.8~48 16.56~48	13.8~60 16.56~60	13.8~60 16.56~60	13.8~75 16.56~75	13.8~94.5 16.56~94.5
	17.25~24 20.7~24	17.25~30 20.7~30	17.25~30 20.7~30	17.25~37.7 20.7~37.7	17.25~48 20.7~48	17.25~60 20.7~60	17.25~60 20.7~60	17.25~75 20.7~75	17.25~94.5 20.7~94.5

13.2 Selective protection in NA1

			Circuit breaker	NA1-2000X/NA1-2000XN/NA1-2000XH			
Downstream		Upstream	Rated current (A)	630	800	1000	1250
			Default setting ratings of short time-delay 8In (kA)	5.04	6.4	8	10
			Setting range (kA)	0.63 ~ 9.45	0.8~12	1~15	1.25~18.75
			Delayed tripping time (s)	0.1, 0.2, 0.3, 0.4			
			Returnable time	0.06, 0.14, 0.23, 0.35			
Frame size rated current	Rated current (A)	Default instantaneous setting ratings 12In (kA)					
NA1-2000X	400	4.8		6.348~9.45	6.348~12	6.348~15	6.348~18.75
	630	7.56			9.998~12	9.998~15	9.998~18.75
	800	9.6				12.696~15	12.696~18.75
	1000	12					15.87~18.75
	1250	15					
NA1-3200X	1600	19.2					
	2000	24					
NA1-4000X	2000	24					
	2500	30					
	3200	38.4					
NA1-6300X	3200	38.4					
	4000	48					
	4000	48					
NA1-6300X	5000	60					
	6300	75					

Note: It can satisfy the selective protection if only the short time-delay setting value of the superior breaker 1.32 times more than the subordinate breaker, when the instantaneous setting value is adjustable.





Intelligent Controller of NA1 series

14. Protection Features of intelligent controller

14.1 M/H and 3M/3H intelligent controller UI

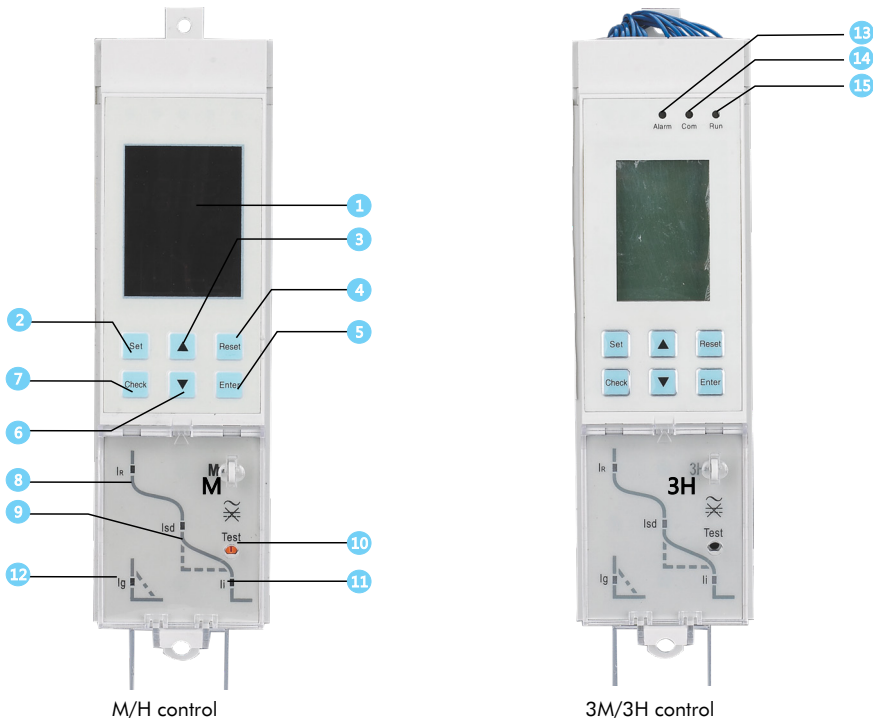

- 1 Display window  
Display current value, setting value, tripping time and so on
- 2 "Set"  
Switch to setting menu
- 3 "Up"  
Change the marquee or the selected parameter
- 4 "Return"  
Escape from this grade and return to upper menu or cancel the current selected parameter
- 5 "Enter"  
Enter into the next menu directed by the current item, or select current parameter and store modifications
- 6 "Down"  
Change the marquee or the selected parameter

- 7 "Check"  
Switch to query menu
- 8 "Ir" light  
Overload long delay fault indication
- 9 "Isd" light  
Short-circuit Short delay indication
- 10 "Test"  
Trip test button
- 11 "li" light  
Short-circuit instantaneous fault indication
- 12 "Ig" light  
Asymmetric earthing or neutral line fault indication
- 13 Alarm light
- 14 Communication light
- 15 Run light

Note: Method of 3M/3H controller application please refer to 3M/3H controller instruction.

14.2 3M/3H controller default interface and menu structure 3M/3H controller has four subjects menus and a default interface:

The subjects menus are composed of 4 parts: measurement menu, parameter set menu, protection parameter set menu, history and maintenance menu.

3M/3H controller default interface

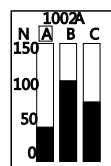

### 14.3 Explanation of M/H controller symbols

#### 14.3.1 Explanation of symbols for reference

No.	symbol	NA1-2000X/NA1-2000XN/NA1-2000XH
1	lr= tr=	Long delay current setting, long delay time setting
2	lsd= tsd=	Short delay current setting, short delay time setting
3	lg= tg=	Earthing current setting, earthing time setting
4	li=	Instantaneous current setting
5	N=	Neutral line protection parameter setting
6	TM	Trip simulated by software
7	TRIP	Tripped
8	RUN	Run normally
9	SET	Normally on: in settable state; Flickering: modifiable parameter
10	LIN	Storing state
11	P   0	Protection setting interface
12	FES	Trip simulated by software setting interface
13	RLR	Alarm setting or query interface
14	SYS	System setting interface (current calibration , frequency setting ...)
15	DBS	Communication setting interface of H-type controller
16	DOS	DO setting interface (H type with DO function )
17	FRU	Fault record query interface
18	COU	Operation times and life query interface
19	HDF	Thermal capacity query interface
20	DOC	DO state query interface
21	H	Thermal capacity data
22	F--	Fault record number
23	R--	Alarm record number
24	Lg L1 L2 L3 LN	Earthing ,A,B,C,N phase
25		The corresponding LED lamp will flash to indicate the fault type after tripping. The LED lamps are always on when the system is normal.

#### 14.3.2 Operation and display instruction

There are four states, default state, setting state, query state and tripping state.

① Default state: default state is also called measuring state. All fault indicating lamps are off and maximum phase current is displayed.

In this state, if "▲" or "▼" button is pressed, L1,L2,L3(LN),Lg current can be displayed in turn.

Example is shown below:

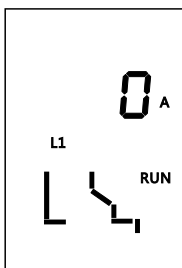

L1 phase current display interface

② Setting state: press "Set" button in default interface to enter into setting interface. Current protection parameters, overload pre-alarm value, earthing alarm threshold value and delay time can be queried or changed in setting state. Tripping can be simulated by software. In this state, "▲" or "▼" button can be pressed to add or subtract value when "SET" indicating lamp is flickering. Don't forget to press "Enter" button to save data after setting.

Example 1 of changing long delay time is shown below:

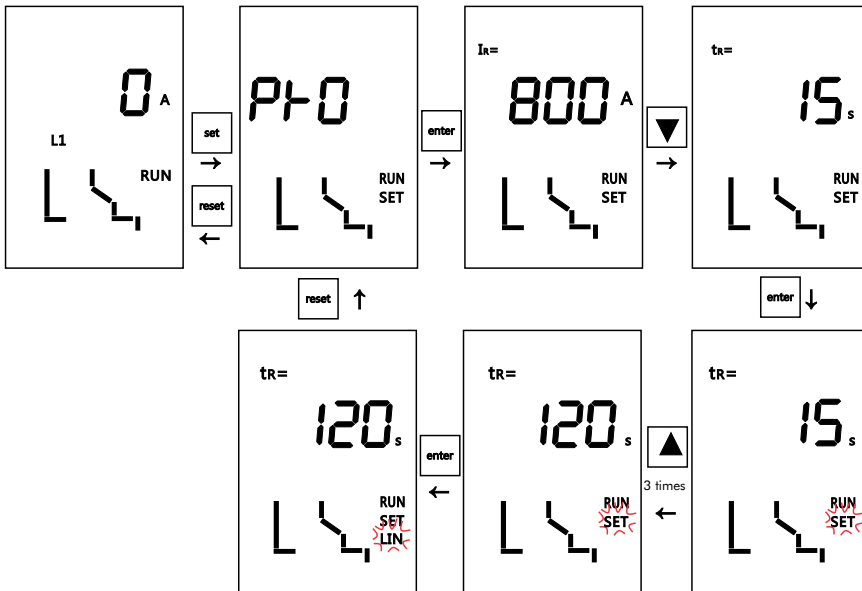

Example 2 of short delay tripping simulated by software is shown below:

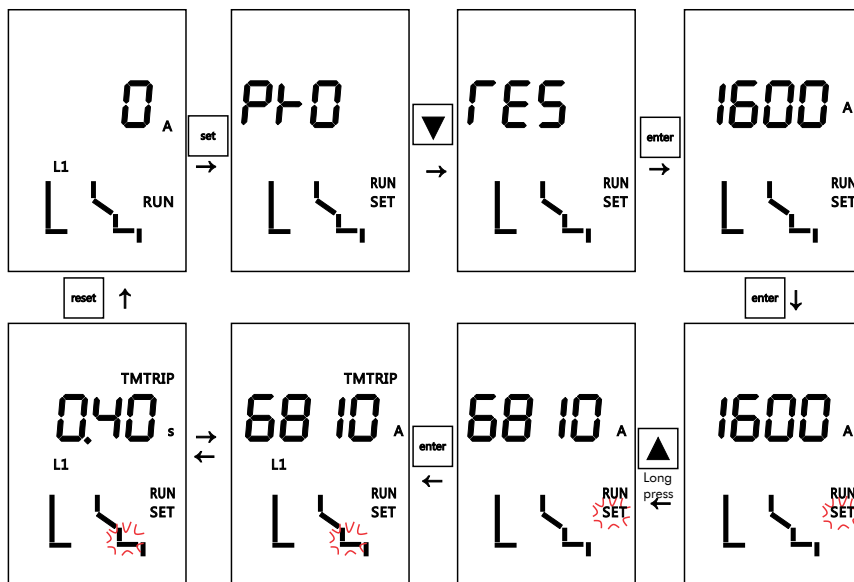

Example3 of setting earthing alarm threshold current is shown below:

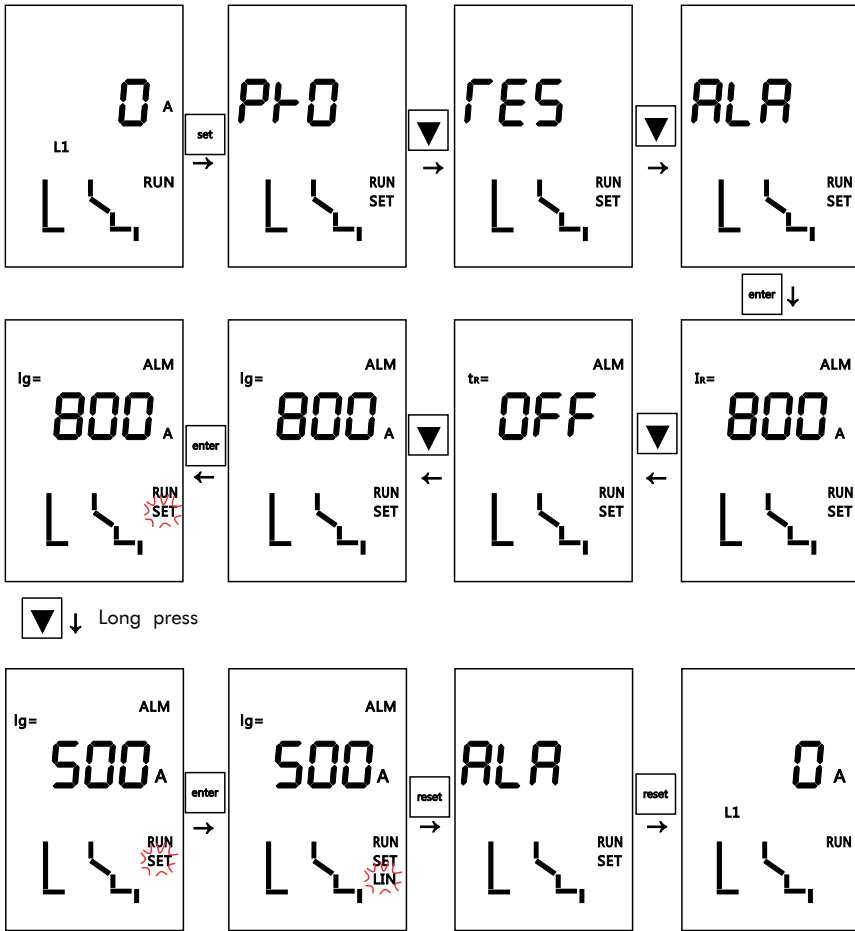

③ Query state: press "Check" button in default interface to enter into query interface. Last 8 fault records, last 8 alarm records, breaker operation times, life record and thermal capacity can be queried in query state.  
Example4 of querying second fault record is shown below:

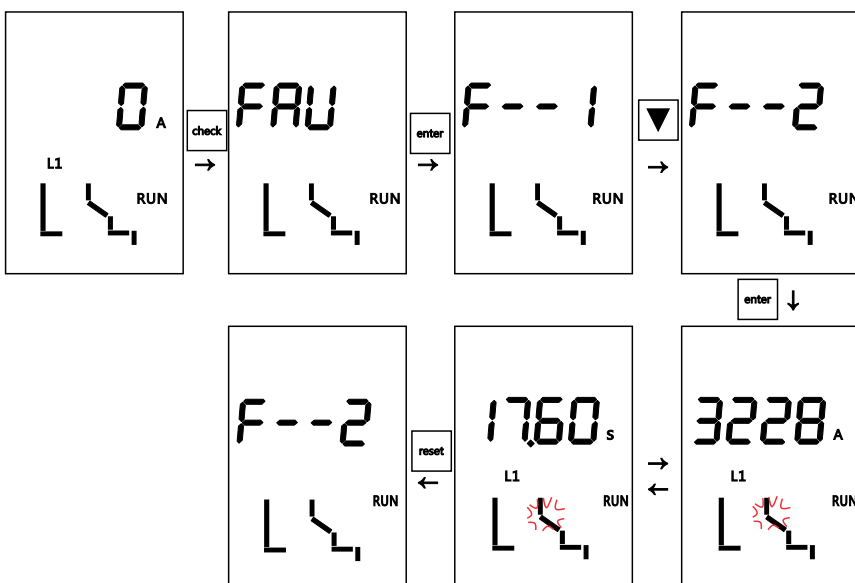

Example5 of querying first alarm record is shown below:

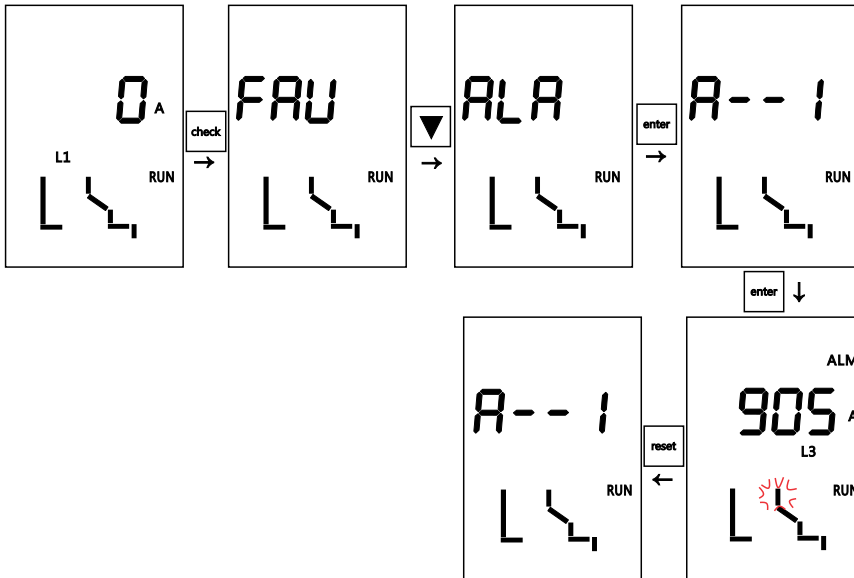

Example6 of querying breaker operation times and life record is shown below:

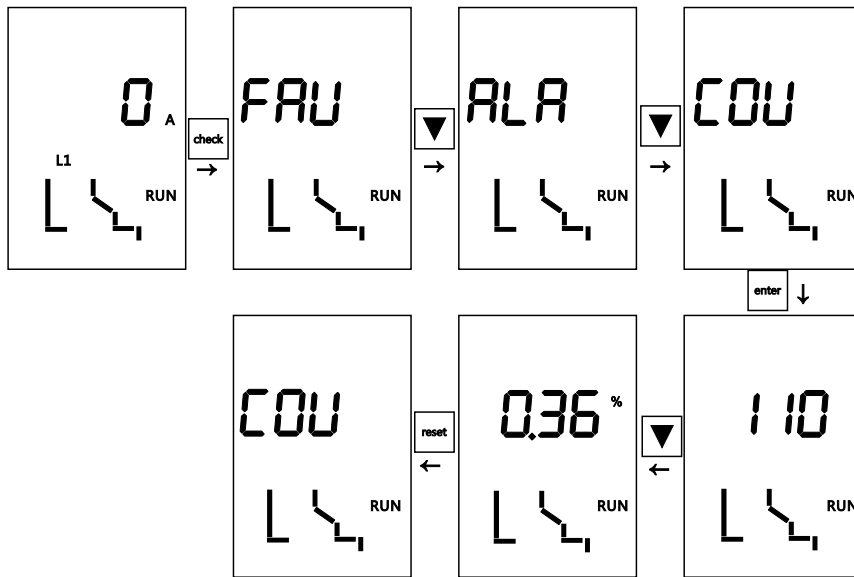

Example7 of querying thermal capacity after tripping is shown below:

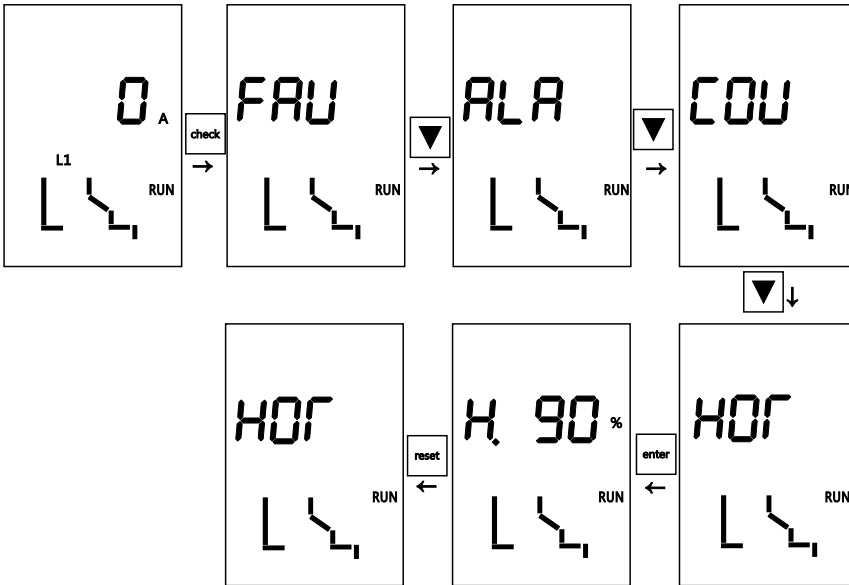

④ Tripping state: "Reset" button should be press to return default interface after tripping at fault.

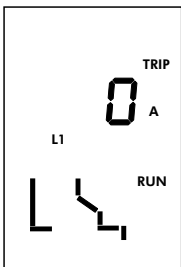

Press "Test" button to simulate Instantaneous trip

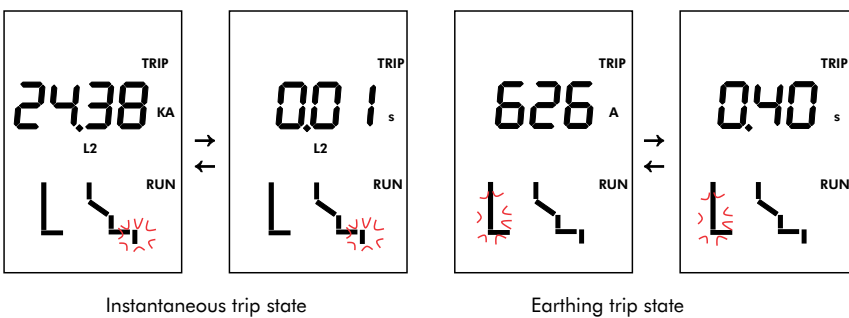

14.3.3 Controller functions list

M type	H type
1 over-current protection (overload, shortdelay,instantaneous,earthing); vector sum grounding mode. 2 Neutral line protection 3 Current measurement 4 two test functions: (1) Instantaneous trip test simulated by mechanical button (2) Other trip tests simulated by software 5 Ten fault records 6 Ten alarm records 7 MCR protection 8 operation times records 9 thermal capacity 10 overload pre-alarm	1 over-current protection (overload, short delay, instantaneous, earthing); vector sum grounding mode. 2 Neutral line protection 3 Current measurement 4 two test functions: (1) Instantaneous trip test simulated by mechanical button (2) Other trip tests simulated by software 5 Ten fault records 6 Ten alarm records 7 MCR protection 8 operation times records 9 thermal capacity 10 overload pre-alarm 11 communication function: MODBUS protocol 12 four DO function (optional)
3M type	3H type
1 all functions of M-type controller are included 2 HMI:128*64 LCD	1 all functions of 3M-type controller are included 2 voltage measurement and protection 3 frequency measurement and protection 4 power measurement and protection 5 electric energy, power-factor, harmonic measurement 6 communication function: MODBUS protocol 7 DI/DO function

14.4 specifications of characteristics

14.4.1 Over-current protection characteristic curve

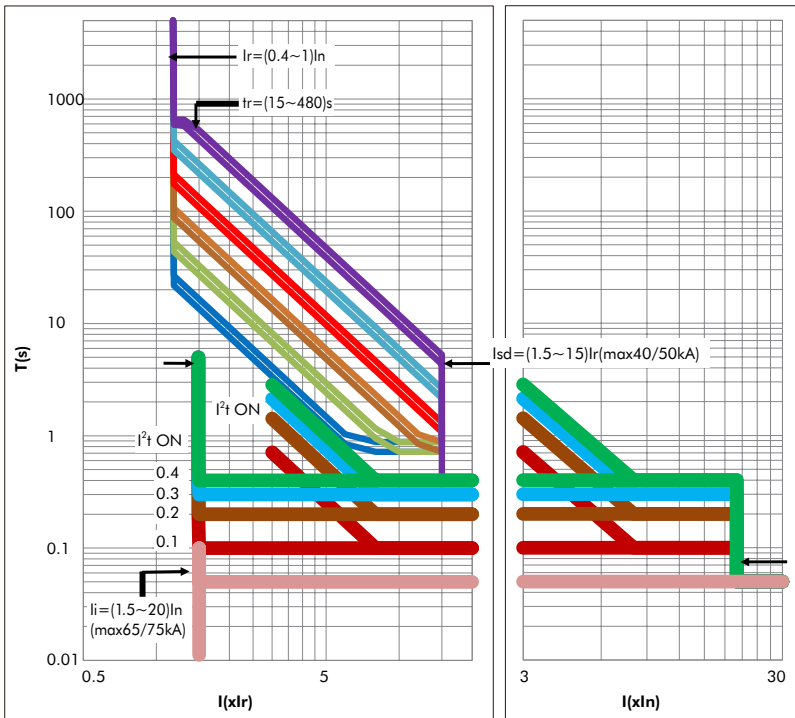

#### 14.4.2 Overload long time-delay protection Operating characteristics

Current Ratings Range(Ir)	tolerance	Current	Action time(s)	Time tolerance					
(0.4~1)In+ OFF	±10%	≤1.05Ir	>2h Non-trip						
		> 1.3Ir	<1h trip						
		1.5Ir(setting time)	15	30	60	120	240	480	±10%
		2.0Ir	8.4	16.9	33.7	67.5	135	270	±10%
Phase N Overload and Over-Current Characteristic			100% or 50%(Applicable to 3P+N or 4P)						

#### 14.3 Short-circuit short-delay protection

Short-circuit short delay protection has two protection modes. One is inverse time and definite time protection.  $I^2T_{sd} = (8I_r)^2 t_{sd}$  works when current is low. In this formula,  $I$  is actual current,  $T_{sd}$  is actual trip time,  $t_{sd}$  is set trip delay time. When  $I$  is over inverse time set value but below  $8I_r$ , controller will operate according to over-current protection characteristic curve. When  $I$  is over both of inverse time set value and  $8I_r$ , controller will operate according to definite time protection. The other is definite time protection and set time is 0.11s, 0.21s, 0.31s, and 0.41s. When  $I$  is over  $I_{sd}$  but below  $I_i$ , controller will operate according to definite time protection.

#### Operating characteristics

Current Ratings Range(I <sub>sd</sub> )	tolerance	Current	Action time(s)	Time tolerance			
(1.5~15)I <sub>r</sub> + OFF	±10%	≤0.9I <sub>sd</sub>	In the 2I <sub>sd</sub> Non-trip				
		> 1.1I <sub>sd</sub>	In the 2I <sub>sd</sub> Delayed-trip				
		t <sub>sd</sub>	0.1	0.2	0.3	0.4	±15%
		Returnable time	0.06	0.14	0.25	0.33	±15%

Note: a. When the intelligent controller is Frame II (I<sub>nm</sub>=3200A、4000A), I<sub>sd</sub> shouldn't be more than 40KA.  
b. When the intelligent controller is Frame III (I<sub>nm</sub>=6300), I<sub>sd</sub> shouldn't be more than 50KA.  
c. When t<sub>sd</sub> is 0.1s or 0.2s, time permissible error is ±0.040s.

#### 14.4.4 Short-circuit instantaneous protection

Tripping time for instantaneous protection (including the inherent breaking time of circuit breaker) should be less than 50ms (effective value protection) or 30ms (peak value protection).

#### Operating characteristics

Current Ratings Range(I <sub>i</sub> )	tolerance	Current	Time tolerance
(1.5~20)I <sub>n</sub> + OFF	±15%	≤0.85I <sub>i</sub>	In the 0.2s Non-trip
		> 1.15I <sub>i</sub>	In the 0.2s trip

Note: a. When the intelligent controller is Frame I (I<sub>nm</sub>=2000A), I<sub>i</sub> shouldn't be more than 50KA.  
b. When the intelligent controller is Frame II (I<sub>nm</sub>=3200A、4000A), I<sub>i</sub> shouldn't be more than 65KA.  
c. When the intelligent controller is Frame III (I<sub>nm</sub>=6300), I<sub>i</sub> shouldn't be more than 75KA.



14.4.5 Earthing protection

Earthing protection has definite time characteristic. Fault delay time is shown below.

Earthing protection characteristic curve

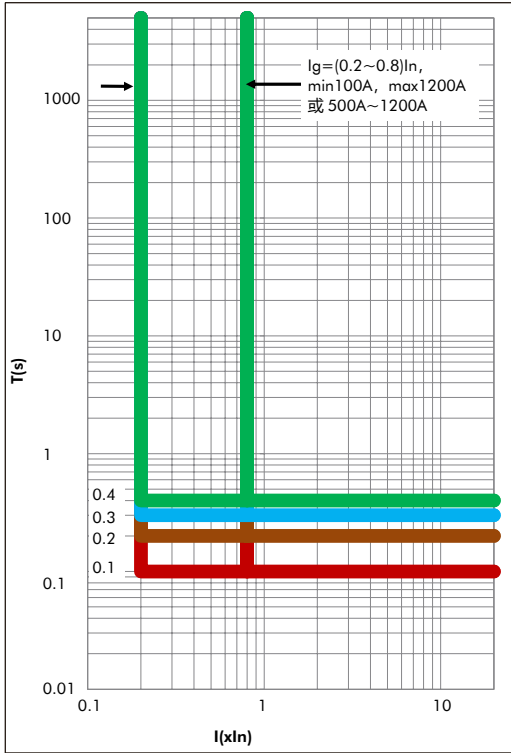

Operating characteristics of single-phase earthing protection

Current Ratings Range(Ir)	tolerance	Current	Action time(s)	Time tolerance			
Inm=1000/2000, (0.2~0.8)In+ OFF Inm=3200/4000/6300, (500~1200)A+ OFF	±10%	≤0.9I <sub>g</sub>	In the 2t <sub>g</sub> Non-tripping				
		> 1.1I <sub>g</sub>	In the t <sub>g</sub> ±0.032s or t <sub>g</sub> (1±25%) Tripping				
		t <sub>g</sub>	0.1	0.2	0.3	0.4	±15%
		Returnable time	0.06	0.14	0.25	0.33	±15%

Note: a. When t<sub>g</sub> is 0.1s or 0.2s, time permissible error is ±0.040s;  
 b. When Inm is 1000A, I<sub>g</sub> should be more than 100A. When Inm is 2000A, I<sub>g</sub> shouldn't be more than 1200A.  
 c. When Inm is 3200A, 4000A or 6300A, I<sub>g</sub> should be between 500A and 1200A.

Single-phase protection is usually used in neutral-point solid ground system. Controller has two different protection modes, being vector sum mode and external transformer mode.

In three-phase three-wire system using 3-pole breaker without external transformer, earthing fault signal comes from three-phase current vector sum. Operating characteristic is definite time protection.

3PT mode

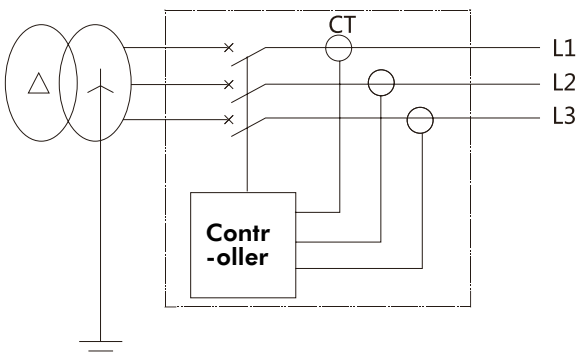

In three-phase four-wire system using 4-pole breaker without external transformer, earthing fault signal comes from three-phase current and N-Pole current vector sum. Operating characteristic is definite time protection.

4PT mode

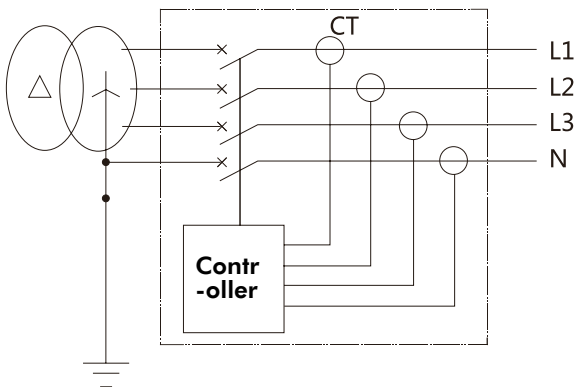

In three-phase four-wire system using 3-pole breaker with external N-pole transformer, earthing fault signal comes from three-phase and N-Pole current vector sum. Operating characteristic is definite time protection.

(3P+N)T mode

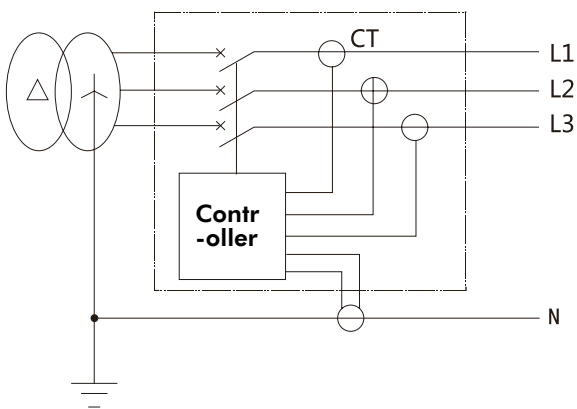

Note:

- ① External N-pole transformer (connected to 6#, 7# terminal for NA1-1000, connected to 25#, 26# terminal for NA1-2000-6300) is a special product. Default lead wire is 2 meters long.
- ② Earthing protection in 3PT mode can only be used in balance load. It should be turned off or set value above allowable unbalance current when the load is unbalance or the controller may operate.
- ③ The distance between external transformer and breaker should be less than 5m in (3P+N)T mode. When lead wire of external transformer needs to be longer than 2 meters, special requirement should be noted when ordering.

## 15. Accessories

### 15.1 Shunt release

The power-on time cannot be greater than 2 seconds / time, and the power-on frequency cannot be greater than 5 times / minute.

- a. The shunt release should be used except for special products where the circuit breaker must be directly disconnected manually;
- b. The shunt release could operated within 10 meters to break the circuit breaker.

Characteristics of shunt release

Rated control power supply voltage $U_s(V)$			AC220/230	AC380/400	DC220	pulse	AC110 ( not available for NA1-1000X )
Operating voltage (V)			(0.7-1.1) $U_s$				
Break time (ms)			≤28				
Power consumption (VA/W)	$I_{nm}=1000A$	pulse	56	56	250	250	-
		Intermittent(default)	300	300	132	70	300
	$I_{nm}=2000A\sim 6300A$	Pulse(option)	880	1800	880	850	850



Notes:

1. It must select pulse type in the automatic control system.
2. power-on time of the intermittent type cannot be greater than 2 s, pulse frequency of the pulse type cannot be more than 5 times/min, or the components are easily burnt;
3. If the circuit breaker is not break by a single power-on of 15 s, must disconnect the power on the shunt release immediately.

15.2 Closed Electromagnet

After the energy storage of the motor is completed, the closed electromagnet can be operated and controlled within a range of 10 meters to instantaneously release the energy storage spring force of the operating mechanism to close the circuit breaker.

Characteristics of closed electromagnet

Rated control power supply voltage Us(V)			AC220/230	AC380/400	DC220	DC110	AC110 (not available for NA1-1000X)
Operating voltage (V)			(0.85-1.1)Us				
Close time (ms)			≤50				
Power consumption (VA/W)	Inm=1000A	pulse	56	56	250	250	-
		Intermittent(default)	300	300	132	70	300
	Inm=2000A~6300A	Pulse(option)	880	1800	880	850	850



Notes:

1. It must select pulse type in the automatic control system.
2. power-on time of the intermittent type cannot be greater than 2 s, pulse frequency of the pulse type cannot be more than 5 times/min, or the components are easily burnt;
3. Ensure that the product is in the energy storage state so that the closed electromagnet may be energized;
- 4.If the product is not closed after a single power-on for 15s, must disconnect the power on the closed electromagnet immediately.

15.3 Undervoltage release (UVT) (The power must be turned on before the circuit breaker is closed)

15.3.1 The undervoltage release has instantaneous operation and delayed operation:

Operation types of each frame under voltage release

	Self-priming	Helped priming
Undervoltage instantaneous release	Inm=1000A, 6300A	Inm=2000A, 3200A, 4000A/3
Undervoltage delay release	Inm=1000A, 6300A	Inm=2000A, 3200A, 4000A/3



Notes:

1. Inm=1000A undervoltage delay does not require an external delay controller. The power-off operation is an instantaneous operation. There is no zero voltage delay function;
2. Inm=6300A undervoltage delay does not require an external undervoltage delay controller. There is a delay function for low voltage and power off;
3. Inm=2000A~4000A/3 undervoltage delay requires an external delay controller. There is a delay operation when the power is off. There is a zero voltage delay function.

Delay time of under voltage release

	Delay time (optional)	Accuracy
Inm=1000A	1 s, 3 s, 5 s, 7 s (not adjustable)	±15%
Inm=2000A~4000A/3	1 s, 3 s, 5 s (non-adjustable)	0~1s
Inm=6300A	0.3 s~7.5 s (adjustable)	±15%

The undervoltage will not operate when the voltage returns to 85% Ue and higher,, within 1/2 delay time.

Note:  
A self-priming undervoltage delay release may be provided for special orders of NA1-2000X~6300X. There is no external undervoltage delay controller, and the delay time is 0.3s~7.5s, selectable and adjustable with an accuracy of ±15%.

15.3.2 When the undervoltage release is not powered, the circuit breaker cannot be closed either electrically or manually:

Characteristics of under voltage release

Rated control power supply voltage Ue(V)	AC110, AC220/230, AC380/400
Operating voltage (V)	(0.35~0.7)Ue
Reliable closing voltage (V)	(0.85~1.1)Ue
Reliable not-closing voltage (V)	≤0.35Ue
Power consumption (Inm=1000A/Inm=2000A~6300A)	20VA/48VA (W)

15.4 The electric energy storage mechanism (the power-on time cannot be greater than 5 seconds / time, and the power-on frequency cannot be greater than 3 times/min) has an automatic re-energy storage function to facilitate dual power switching.

Characteristics of electric energy storage mechanism

Rated control power supply voltage Ue(V)	AC380, AC220	DC220, DC110
Operating voltage (V)	(0.85-1.1)Us	(0.85-1.1)Us
Power consumption (Inm=1000A)	90W	90W
Power consumption (Inm=2000A)	85W	85W
Power consumption (Inm=3200A, 4000A/3)	110W	110W
Power consumption (Inm=6300A)	150W	150W
Energy storage time	≤5s	≤5s



Notes:

1. It is forbidden to turn on the power for 7 seconds to avoid damage.

15.5 Auxiliary contact NO

Standard type: Provides users with 4 sets of conversion contacts (default configuration).  
 Special type: 6 sets of Inm=1000A conversion contacts (for AC only);

Characteristic

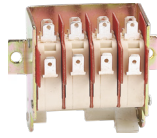

Type	NA1-1000X			NA1-2000X/NA1-2000XN/NA1-2000XH/NA1-3200X/NA1-3200XN/NA1-4000X/NA1-6300X/NA1-6300XN		
Rated voltage (V)	AC230	AC400	DC220	AC230	AC400	DC220
conventional free-air thermal current Ith (A)	10	6	0.5	6	6	6
Rated control capacity	300VA	100VA	60W	300VA	300VA	60W

NA1-1000X			NA1-2000X/NA1-2000XN/NA1-2000XH/NA1-3200X/NA1-3200XN/NA1-4000X/NA1-6300X/NA1-6300XN		
Category	Voltage	Current	Category	Voltage	Current
AC-15	AC230V	1.3A	AC-15	AC230V	1.3A
	AC400V	0.25A		AC400V	0.75A
DC-13	DC110V	0.55A	DC-13	DC110V	0.55A
	DC220V	0.27A		DC220V	0.27A

15.6 Doorcase

Installed on the door of the distribution cubicle, for sealing the distribution cubicle and making the protection class to IP40( fixed type and drawout type).

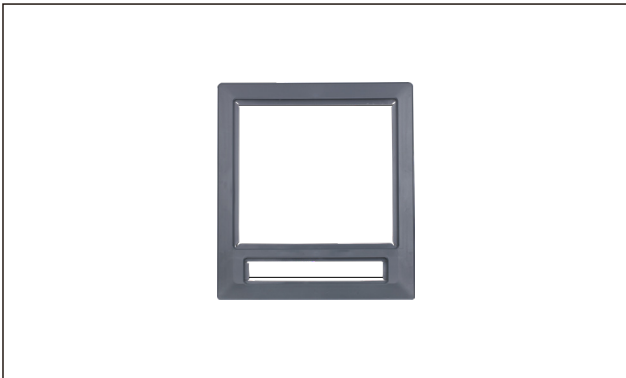

15.7 Phases barrier (Optional)

Installed between the busbars to increase the creepage distance.



15.8 Transparent shield (NA1-2000) (Optional)

Installed on the doorcase of the cubicle's small door, make the protection class to IP54. It is suitable for the fixed, drawout type circuit breaker and the load switch.



15.9 Off position locking mechanism

When the circuit breaker is disconnected, padlock can be used to lock it after pulling out the lock lever, then the circuit breaker can't be "Test" or "connected" position.( Padlock is prepared by users)

15.10 Key lock

Lock the circuit breaker on the OFF position, then the circuit breaker can't be closed.

Locks and keys will be provided by us.

Separate lock and key is matched with one set of the circuit breaker.

Three same locks and two same keys are matched with three circuit breaker.

Note: Before pulling out the key, the break pushbutton should be pressed first, rotate the key anticlockwise, then pull it out.

★ NA1 Install the locking system

1. Components of the locking system:



2. Installation sequence:

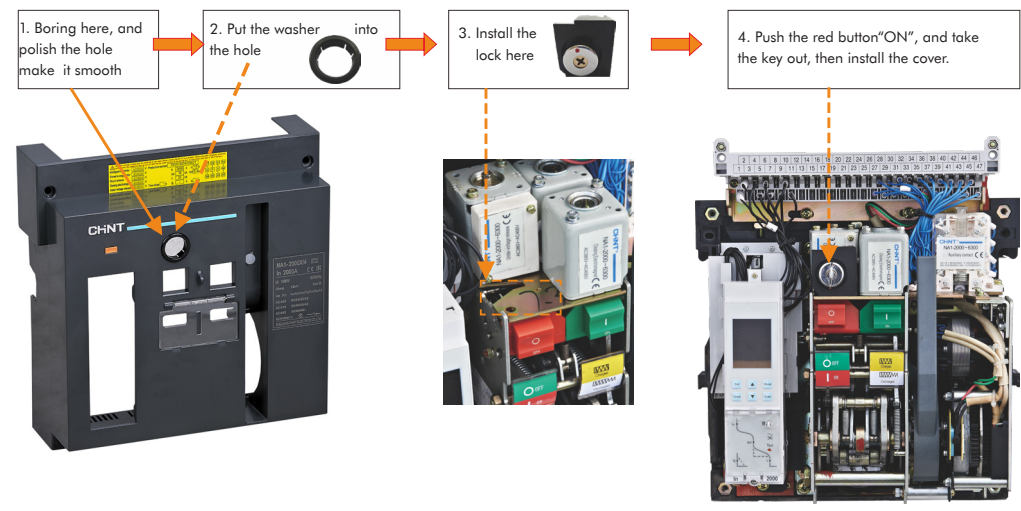

15.11 Cable mechanical interlock

It can realize the interlock of two horizontal or vertical-installed, three poles or four poles, drawout type or fixed type circuit breaker.

- a. If need bend the cable, make sure the radian is more than 120°.
- b. Check and make sure enough lubricating oil of the cable.
- c. The maximum distance between two interlock circuit breakers is 1.5m.

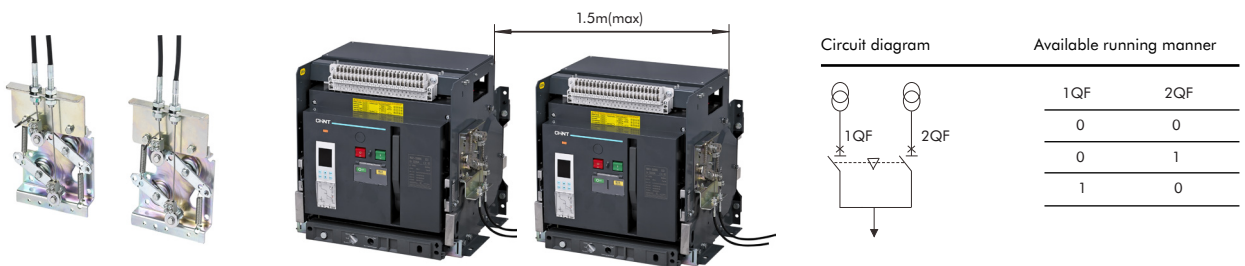

Notes:

- a. when the steel cable needs to be bent, enough transition arc should be reserved to guarantee flexible movement of steel cable;
- b. check the steel cable and make sure there is enough lubricant in the steel cable to guarantee flexible movement of steel cable.

15.12 Connecting-rod type mechanical interlock

For two vertically mounted three-pole or four-pole circuit breakers, the interlock can be realized where one makes and the other breaks.

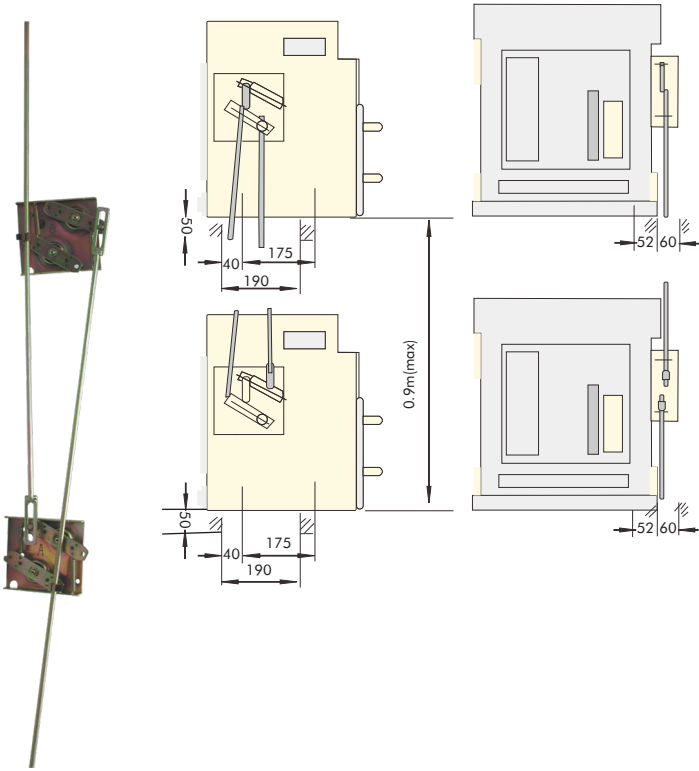

Circuit diagram

Available running manner

Manner 1: three power supplies are provided for one circuit breaker only

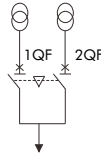

	1QF	2QF
	0	0
	0	1
	1	0

## 16. Maintenance and Overhaul of Circuit Breaker

### Safety Precautions

The following operations must be executed in turn before conducting the maintenance or overhaul of circuit breakers:

- Circuit breaker opening operation to ensure the circuit breaker is in an opening state;
- Disconnecting the upper-level knife switch (if any) to ensure the main circuit and secondary circuit are uncharged;
- Circuit breaker discharging, opening operation to ensure the circuit breaker is in a discharging and opening state;
- The components which the personnel might contact must be uncharged.



Keep Safe

### Maintenance and overhaul cycle

Condition	Environment	Maintenance cycle	Overhaul cycle	Remarks
General environment	The air should be always kept clean and dry. There is no corrosive gas. The temperature is in between -5°C ~+40°C The humidity should conform to Specification 1.3 Operating Conditions c Requirement for extreme atmosphere conditions.	Every six months	Once per year (every six months for more than 3 years of mounting period)	Confirming to IEC60947-2 Requirement for general environmental conditions.
Severe environment	Low temperature -5°C ~-40°C or high temperature 40°C ~ 65°C or humidity≥90%	Every three months	Every six months (every three months for more than 3 years of mounting period)	
	Places with more dust and corrosive gases	Every month	Every three months	

### 16.1 Maintenance of circuit breaker

16.1.1 Foreign objects (such as tools, wire leads or fragments, metal objects) in the switchgear should be regularly cleared.

16.1.2 The dust on the circuit breaker must be regularly cleared to maintain its good insulation.

16.1.3 The spring washers of the main circuit connecting bolts, the earthing bolts must be checked for whether they are flattened and the connection is firm.



16.1.4 Whether the opening or closing indication is correct and reliable.

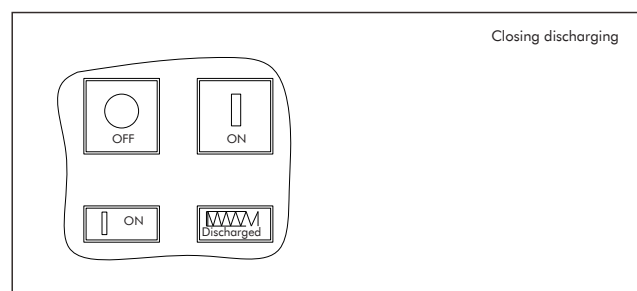
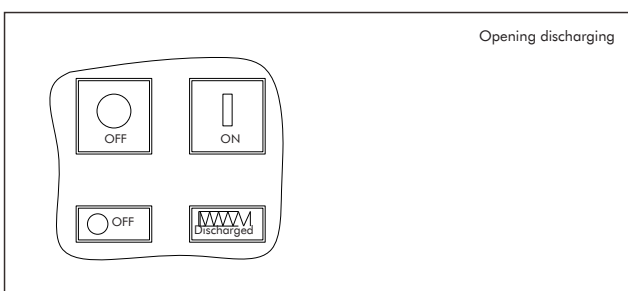
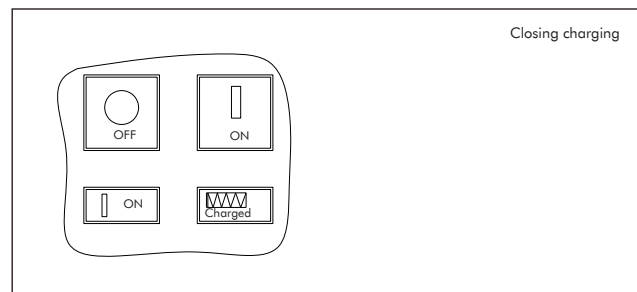
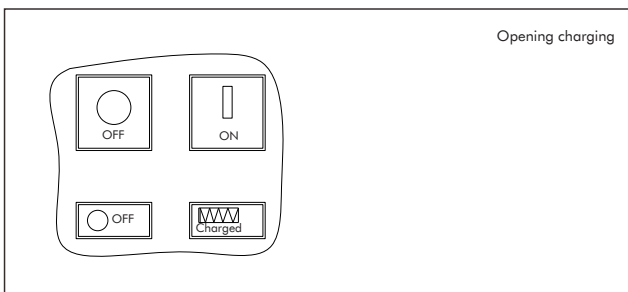

## 16.2 Overhaul of circuit breaker

### 16.2.1 Connecting and mounting inspection

It is proposed to refer to the following requirement for the torsional forces of main circuit and secondary circuit.

Fastener specification	Torque requirement N·m
M3	0.4~0.5
M4	1.2~1.7
M8	16~26
M10	36~52
M12	61~94

### 16.2.2 Insulating property test

The phase-phase and phase-earth insulation resistance, requirement  $\geq 20M\Omega$ .

The insulation resistance test must be first done after overhaul and long-time ( $\geq 7$ days) of deenergization and before energization again.

### 16.2.3 Operating characteristic inspection

All accessories shall be connected with corresponding rated voltage according to the face shield nameplate requirement, and the following operations should be done:

Electric charging, closing and opening operation, 5times in cycle

Manual charging, closing and opening operation, 5times in cycle

The circuit breaker charging, opening and closing should be normal.

Note: The main circuit must be uncharged. If there is an under-voltage release, the rated voltage must be first connected.

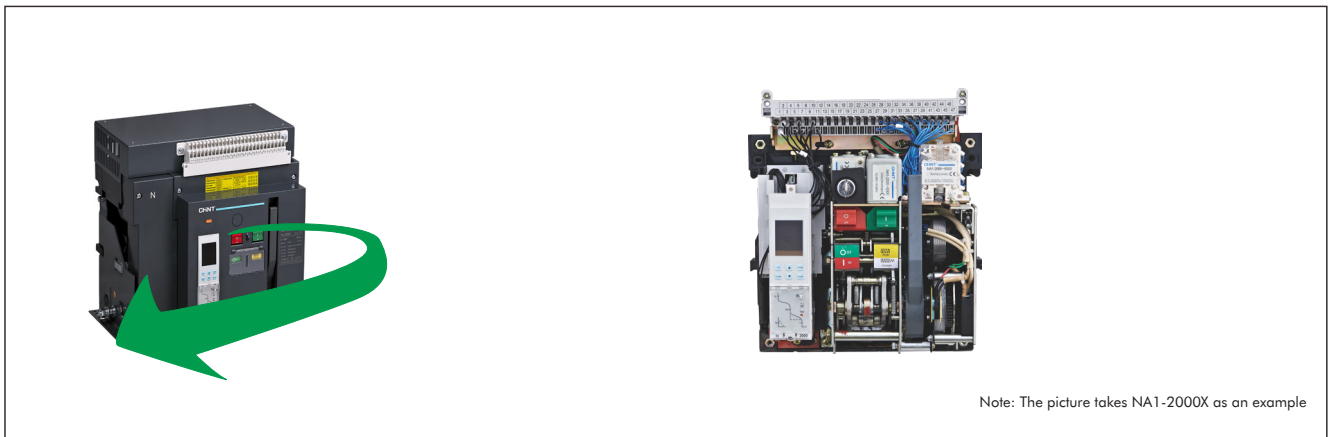



16.2.4 Inspection of circuit breaker components  
 16.2.4.1 Face shield dismantling

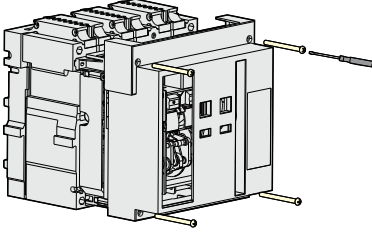

- Remove four bolts of circuit breaker fixed panel and take off the face shield.

Note: The picture takes NA1-2000X as an example.

16.2.4.2 Operating mechanism inspection

The mechanism components should be free of fracture and damage, and the fasteners are fastened.  
 Clear the dust and evenly apply oil onto the rotating components.

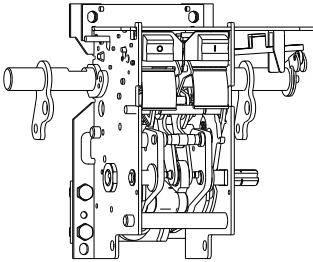

- Evenly apply 7012 low-temperature lubricating grease or lubricate same using the similar solid grease onto the mechanism rotating positions.

Note: The picture takes NA1-2000X as an example.

16.2.4.3 Intelligent controller (taking NA1-2000 type M type controller as an example)

Parameter setting should conform to the site use requirement.



- 1. Press the "Set" button to enter the parameter setting interface "Pro".
- 2. Press the "Enter" button to enter the protective parameter setting and query interface.
- 3. Press the "▲" or "▼" button to in turn select the display of protective parameter setting details.
- 4. Press the "Reset" button to return to the upper-level menu or exit from the interface.

Simulated test tripping function



- Press the "Test" button to simulate the tripping test.



- Press the orange "Reset" button on the face shield to return to normal state.

16.2.4.4 Drawer set inspection (conduct the test after removing the body, taking NA1-2000X as an example)  
There are no foreign objects inside.

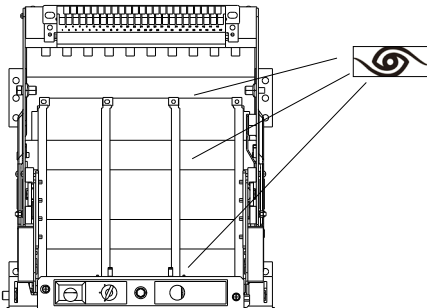

- Observe whether there are foreign objects inside the draw-out socket, like screws, wire leads, scrap iron; please clear same if any.

The flash barrier opening or closing is normal, and the spacing contact has no deformation or oxidization.

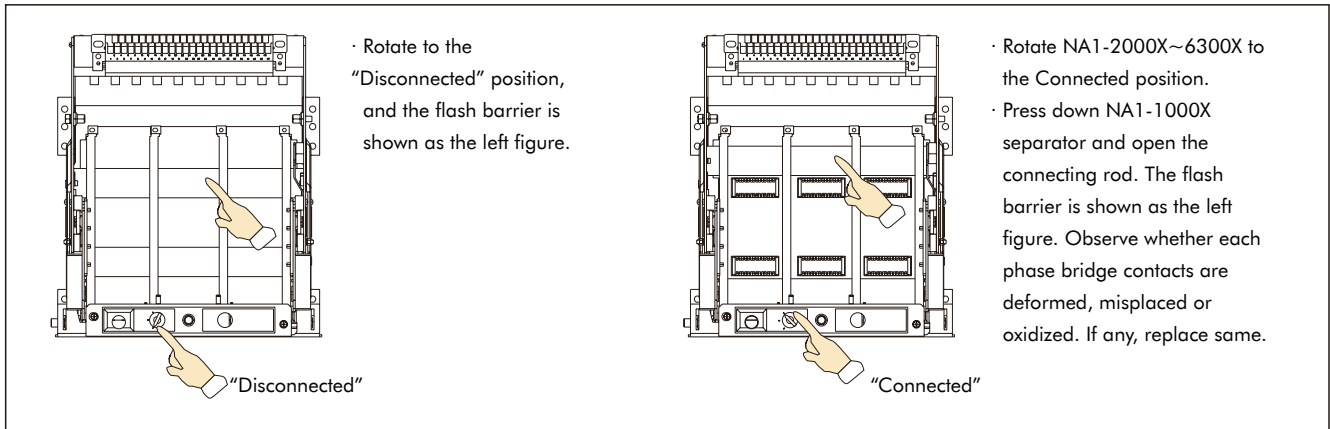

Rotate the friction positions and apply oil evenly.

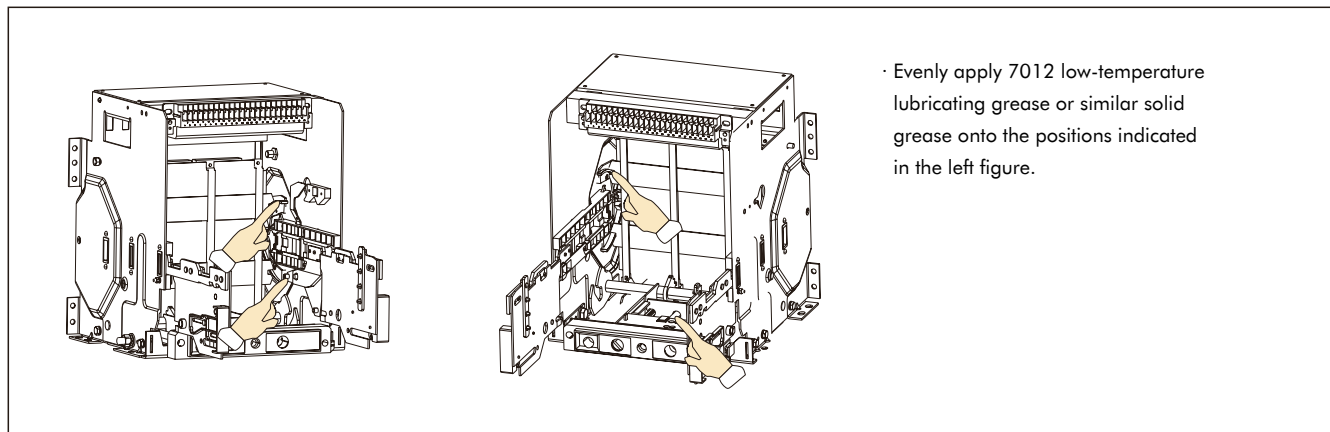

#### 16.2.4.5 Arcing Chamber (taking NA1-2000X~6300X as an example)

Each arc and arcing chambers are not broken. If any, please promptly replace same and clear inside dust, corrosion layer and arc discharge point. In case of serious corrosion or rust, please promptly conduct replacement.

Note: Inspection must be done after short-circuit current breaking.

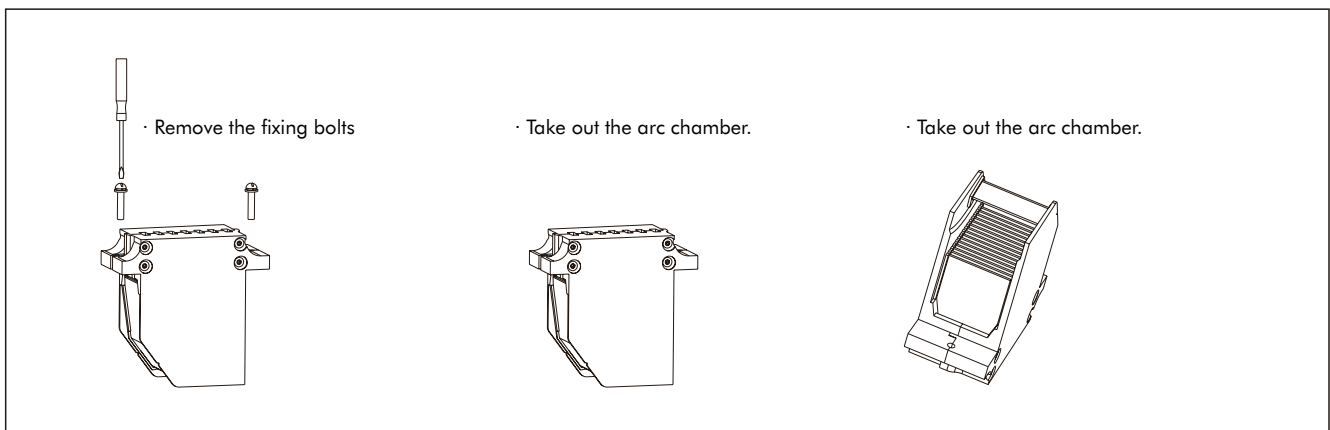

#### 16.2.4.6 Required main contact (taking NA1-2000X~6300X as an example) over-travel $\geq 2$ mm.

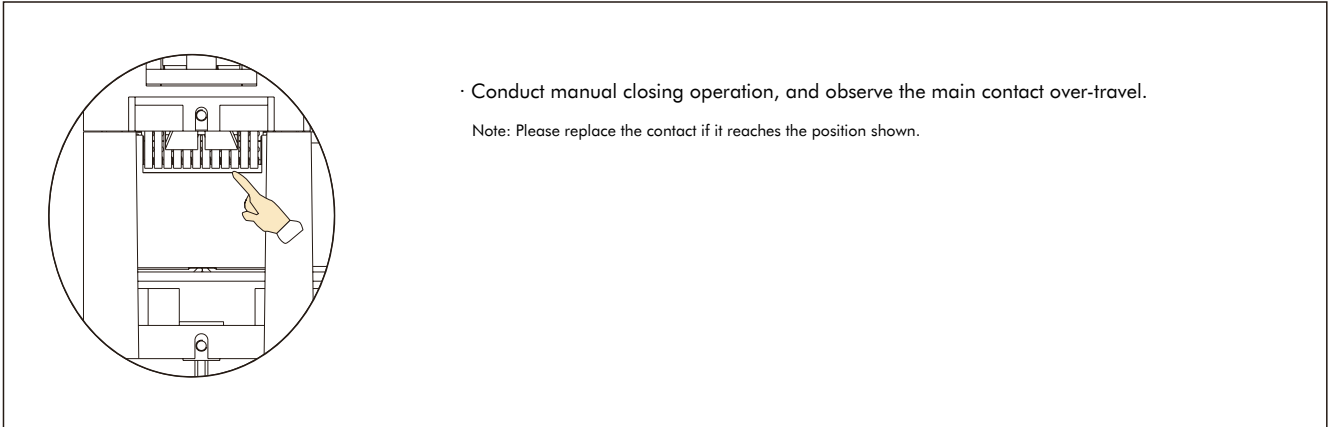

Clear dust, corrosion layer and particle burnt objects.

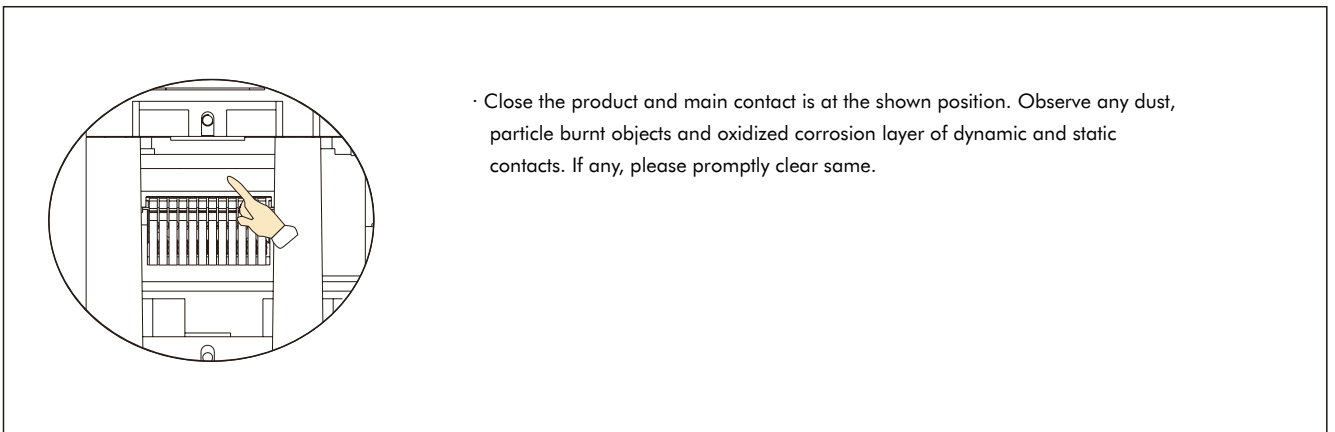

Note: Inspection must be done after short-circuit current breaking.

#### 16.2.4.7 Secondary circuit inspection

No shell damage.

Inspect the contact between the draw-out body secondary circuit and drawer set secondary circuit using the multimeter.

At the "Test" or "Connection" position, the contacts are in good contact, and the connecting screws are fastened, and the conductor insulation has no damage.



16.3 Replacement of undervoltage release, shunt release and closed electromagnet accessories. The following operations must be executed before replacing the accessories.

Cut off all power supplies and ensure the main circuit and secondary circuit power supplies are uncharged. The circuit breakers are in the discharging opening state.

##### 16.3.1 Replacement of fixed accessories

Remove the panel fixing bolts and dismantle the panel.

Untie the tape and remove the connecting conductor.

Remove the fixed accessory mounting screws.

Dismantle the accessories and replace same.

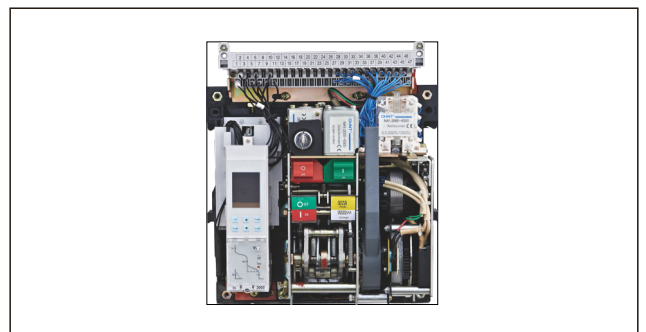

Note: The shunt release should be first dismantled before replacing the NA1-2000 undervoltage release.

16.3.2 Replacement of draw-out accessories

- Rotate the body to the detachment position and remove the body.
- Remove the panel fixing bolts and dismantle the panel.
- Untie the tape and remove the connecting conductor.
- Remove the fixed accessory mounting screws.
- Dismantle the accessories and replace same.

Note: The shunt release should be first dismantled before replacing the NA1-2000 undervoltage release.

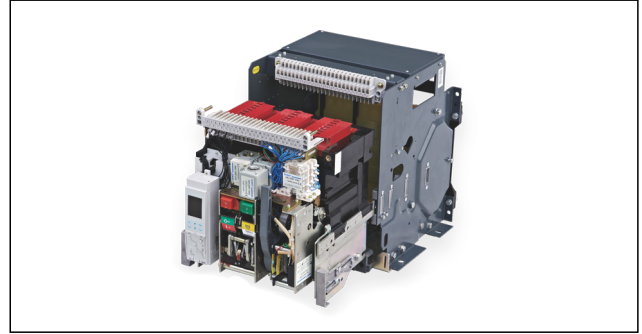

17. Common Failure Causes and Solutions

17.1 Troubleshooting logic

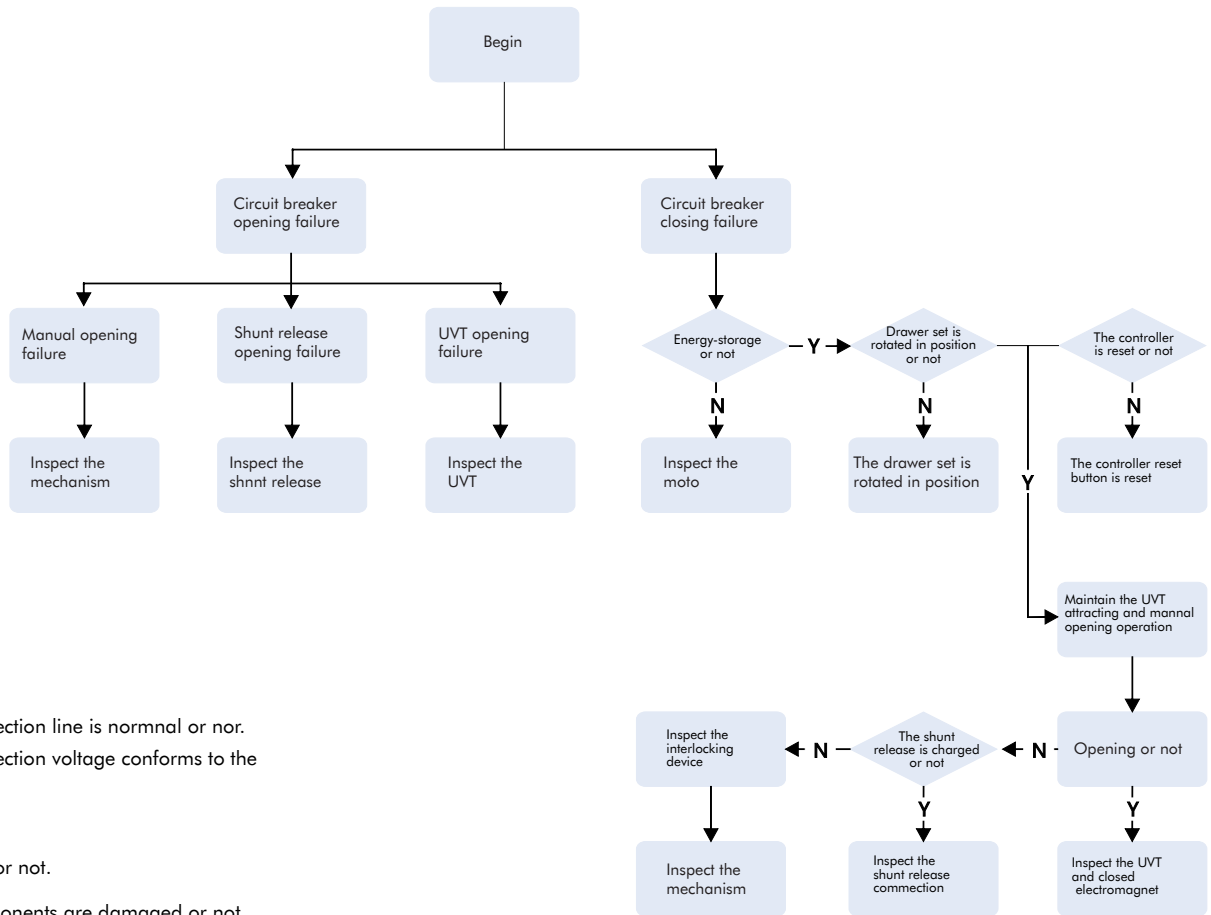

Inspect items:

- 1、 The connection line is normal or not.
- 2、 The connection voltage conforms to the requirement or not.
- 3、 The components are damaged or not. please replace the damaged components

## 17.2 Faulty tripping analysis (taking NA1-2000X M as an example) Failure cause identification.

The failures are identified through the intelligent controller indication.

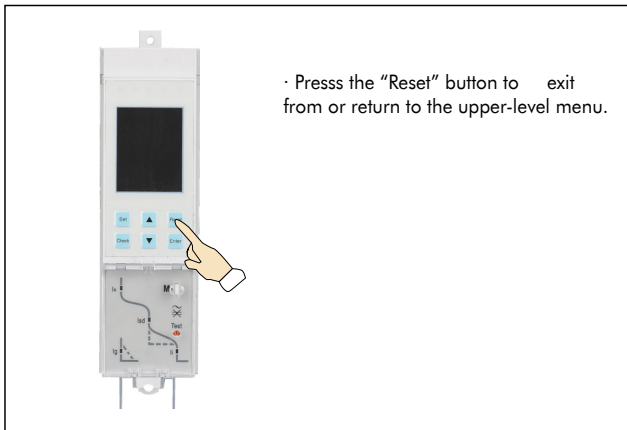
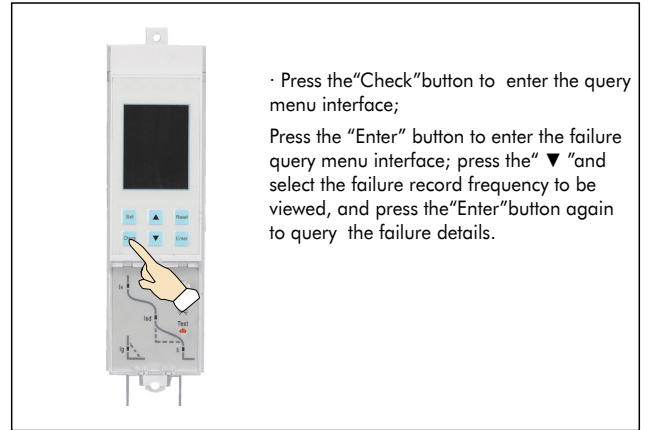
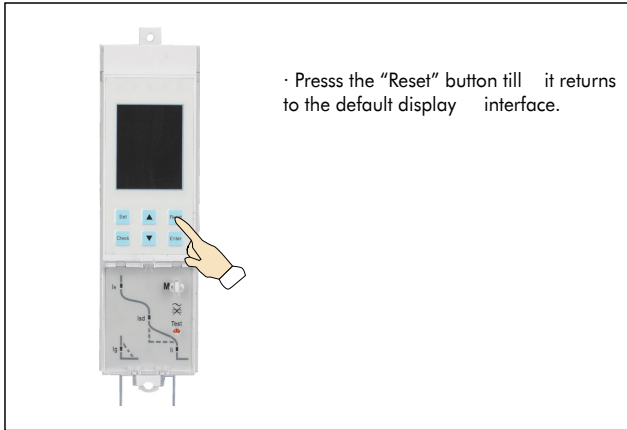

Note: The electrical closing operation is forbidden before troubleshooting.

## 18. Regular malfunction and solutions

Fault description	Reasons analysis	Maintenance method
Tripping of circuit breaker	Over load tripping (Ir indicator flashing)	<ol style="list-style-type: none"> <li>1. Check the breaking current value and operation time of intelligent release.</li> <li>2. Analyze the load and electric network, exclude the overload if it happens.</li> <li>3. Match the actual operating current with long time-delay current setting value.</li> <li>4. Press the reset button to reclose the breaker</li> </ol>
	Short circuit tripping ("Isd" or "li" indicator flashing)	<ol style="list-style-type: none"> <li>1. Check the breaking current value and operation time of intelligent release.</li> <li>2. Exclude the short circuit fault if it happens</li> <li>3. Check the setting value of intelligent release</li> <li>4. Check the normal state of breaker</li> <li>5. Press the reset button to reclose the breaker</li> </ol>
	Earthing fault tripping (IG indicator flashing)	<ol style="list-style-type: none"> <li>1. Check the breaking current value and acting time of intelligent release.</li> <li>2. Exclude the earthing fault if that happens.</li> <li>3. Match the fault current setting value with the actual protection.</li> <li>4. Press the reset button to reclose the breaker.</li> </ol>
	Under-voltage release fault: 1. Rated working voltage is less than 70%Ue 2. Fault of control unit	<ol style="list-style-type: none"> <li>1. Check the power is on or not</li> <li>2. Check the power voltage of under-voltage release, it shouldn't be less than 85%Ue.</li> <li>3. Replace the control unit of under-voltage release</li> </ol>
	Mechanical interlock acting	Check the working state of two circuit breakers fixed with mechanical interlock
The breaker can't be closed	Intelligent release don't reset (panel is raised)	Press the reset button to reclose the breaker
	Secondary circuit of drawerout-type breaker isn't connected	Make the breaker to "making" position ("click" sound will be heard)
	Breaker hasn't stored energy	Check the secondary circuit: <ol style="list-style-type: none"> <li>1. Power voltage of motor shouldn't less than 85%Ue.</li> <li>2. Check the storage mechanism, replace it if necessary.</li> </ol>
The breaker can't be closed	Mechanical interlock acting leads to locking of breaker	Check the working state of two circuit breakers fixed with mechanical interlock
	Closing electromagnet: 1. Rated control voltage is less than 85%Us; 2. Closing electromagnet is damaged	<ol style="list-style-type: none"> <li>1. Power voltage of closing electromagnet shouldn't less than 85%Us.</li> <li>2. Replace the electromagnet.</li> </ol>
Tripping after closing the circuit breaker (Fault indicator flashing)	Tripping immediately: <ol style="list-style-type: none"> <li>1. Short circuit current is closed</li> <li>2. Delay tripping because of transient current is high when closing;</li> <li>3. Overload current is closed</li> </ol>	<ol style="list-style-type: none"> <li>1. Check the breaking current value and operation time of intelligent release;</li> <li>2. Exclude the short circuit fault if it happens;</li> <li>3. Exclude overload fault</li> <li>4. Check the normal state of breaker</li> <li>5. Modify the current setting value of intelligent release</li> <li>6. Press the reset button to reclose the breaker</li> </ol>
Circuit breaker can't be opened	The breaker can't be opened manually 1. There is fault with mechanical operating mechanism	1. Check the mechanism, if there is fault happened.
	The breaker can't be opened by motor remotely 1. There is fault with mechanical operating mechanism 2. Power voltage of shunt release is less than 70%Us; 3. Shunt release is damaged	<ol style="list-style-type: none"> <li>1. Check the mechanism, if there is fault happened.</li> <li>2. Check the Power voltage of shunt release is less than 70%Us or not</li> <li>3. Replace shunt release</li> </ol>

Fault description	Reasons analysis	Maintenance method
Circuit breaker can't store energy	Manual storage can't be realized	Mechanical fault with the energy-storage device
	Motor storage can't be realized 1. Power voltage of motor energy-stored device is less than 85%Us; 2. There is mechanical fault with energy-storage device	1. Power voltage of motor energy-stored device shouldn't less than 85%Us 2. Mechanical fault with the energy-storage device
Handle of drawerout-type circuit breaker can't be drawn in or out	1. There is padlock at the "opening" position 2. Slideway or breaker body isn't pulled into its position	1. Take away the padlock 2. Pull the slideway or breaker body into its position
Drawerout-type breaker can't be drawn out at the "opening" position	1. Handle isn't pulled out 2. Breaker is not totally at the "opening" position	1. Pull out the handle 2. Keep the circuit breaker totally at "opening" position
Drawerout-type breaker can't reach the "making" position	1. Something drop into the drawer base, and lock the mechanism or mechanism fault happens. 2. Breaker body not match with the frame -size rated current of drawer base	1. Check and clean the drawer base, or contact with manufacturer 2. Match the body with relevant drawer base
No display on intelligent release panel	1. Release isn't connected with power 2. There is fault with release	1. Check the power is connected or not 2. Cut off the power, then connect again. Otherwise contact with manufacturer
	Rated control voltage is less than 85%Us;	Check the electromagnet power voltage shouldn't be less than 85%Us.
Fault indicator still flashing after pressing the Reset button	Fault happened with intelligent release	Cut off the power, then connect again. Otherwise contact with manufacturer



### NA1-1000X~6300X Ordering specification

Customer:

Tel:

Date:

Quantity:

Model	<input type="checkbox"/> NA1-1000X	<input type="checkbox"/> NA1-2000X <input type="checkbox"/> NA1-2000XN <input type="checkbox"/> NA1-2000XH	<input type="checkbox"/> NA1-3200X <input type="checkbox"/> NA1-3200XN	NA1-4000X	<input type="checkbox"/> NA1-6300X <input type="checkbox"/> NA1-6300XN
Rated current In (A)	<input type="checkbox"/> 200 <input type="checkbox"/> 400 <input type="checkbox"/> 630 <input type="checkbox"/> 800 <input type="checkbox"/> 1000	<input type="checkbox"/> 630 <input type="checkbox"/> 800 <input type="checkbox"/> 1000 <input type="checkbox"/> 1250 <input type="checkbox"/> 1600 <input type="checkbox"/> 2000	<input type="checkbox"/> 2000 <input type="checkbox"/> 2500 <input type="checkbox"/> 3200	<input type="checkbox"/> 4000	<input type="checkbox"/> 4000 <input type="checkbox"/> 5000 <input type="checkbox"/> 6300(no four poles)
Installation mode	<input type="checkbox"/> Drawout type <input type="checkbox"/> Fixed type (Note: no fixed type when In > 4000A)				
Number of poles	<input type="checkbox"/> Three poles <input type="checkbox"/> Four poles				
Intelligent Controller	<input type="checkbox"/> M type Standard (Default configuration)	Protection function 1. <input type="checkbox"/> Ir overload long delay, lsd short-circuit short delay inverse time + definite time, li transient short-circuit, lg single-phase grounding 4-section protection 2. <input type="checkbox"/> Ir overload long delay, lsd definite time short-circuit short delay, li transient short-circuit, lg single-phase grounding 4-section protection		Auxiliary functions	Optional function
	<input type="checkbox"/> 3M type Multifunctional (Optional configuration)	1. <input type="checkbox"/> Ir overload long delay, lsd short-circuit short delay inverse time + definite time, li transient short-circuit, lg single-phase grounding 4-section protection 2. <input type="checkbox"/> Ir overload long delay, lsd definite time short-circuit short delay, li transient short-circuit, lg single-phase grounding 4-section protection		1. Ammeter function 2. Self-diagnostic function 3. Tuning function 4. Test function 5 Display function	<input type="checkbox"/> Voltage display <input type="checkbox"/> Frequency display <input type="checkbox"/> Power Factor show <input type="checkbox"/> Active power display <input type="checkbox"/> Load monitoring function Note: For the specific optional function, refer to List of controller functions in the sample (The cost of optional functions will be calculated additionally).
	<input type="checkbox"/> 3H-type Communication type (Optional configuration)	1. <input type="checkbox"/> Ir overload long delay lsd short-circuit short delay inverse time + definite time li transient short-circuit, lg single-phase grounding 4-section protection 2. <input type="checkbox"/> Ir overload long delay, lsd definite time short-circuit short delay, li transient short-circuit, lg single-phase grounding 4-section protection 3. <input type="checkbox"/> with PROFIBUS-DP communication protocol <input type="checkbox"/> with MODBUS communication protocol			
	Notes: Protection function Settable range and conventional factory tuning	Ir long delay current setting range: (0.4 to 1) In Overload 1.5Ir action time setting range: 15,30,60 ..... 480s		! Conventional factory tuning: overload long delay 1.0In ! Conventional factory tuning: overload 1.5Ir; action 15s	
	lsd short delay current setting range: (1.5 to 15) Ir; short delay action time (0.1 ~ 0.4) s		! Conventional factory setting: short delay current 8Ir ; ! Conventional factory tuning: Short delay action time 0.4s [Note: 3M, 3H for (1.5 to 15) Ir]		
	li instantaneous current setting range: 1.5In ~ 50kA/65kA/75kA ! Conventional factory tuning: 12In [Note: 3M, 3H for (1.5In~50kA/65kA/75kA)				
	lg earthing protection current setting range: (0.2 to 0.8) In; the earthing protection time setting range: (0.1to0.4)s ! Conventional factory setting: 0.5 In; OFF				
Controller power	<input type="checkbox"/> AC380V, <input type="checkbox"/> AC400V, <input type="checkbox"/> AC220V, <input type="checkbox"/> AC230V, <input type="checkbox"/> AC127V, <input type="checkbox"/> DC220V, <input type="checkbox"/> DC110V				(Optional)
Electrical accessories	Under voltage release	<input type="checkbox"/> AC110V, <input type="checkbox"/> AC220/230V, <input type="checkbox"/> AC380/400V, <input type="checkbox"/> Order ____ V , <input type="checkbox"/> Non-undervoltage			(No AC110V for NA1-1000X)
	Shunt release	<input type="checkbox"/> Helped & instantaneous <input type="checkbox"/> Helped & delay __s (Inm≥2000A, 1 s, 3 s, 5 s, non-adjustable); <input type="checkbox"/> self-priming & instantaneous <input type="checkbox"/> self-priming & delay __s (Inm≥2000A, 0.3 s~7.5 s,adjustable); Note: Inm=1000A no Helped priming type, delay time 1 s, 3 s, 5 s, 7 s,non-adjustable.			
	Closing electromagnet	<input type="checkbox"/> intermittent (only for Inm≥2000A and default) <input type="checkbox"/> AC110V, <input type="checkbox"/> AC220/230V, <input type="checkbox"/> AC380/400V, <input type="checkbox"/> DC110V, <input type="checkbox"/> DC220V			
	Electric motor	<input type="checkbox"/> pulse (must select in automatic control system) <input type="checkbox"/> AC110V, <input type="checkbox"/> AC220/230V, <input type="checkbox"/> AC380/400V, <input type="checkbox"/> DC110V, <input type="checkbox"/> DC220V			
Special requirements	Interlock device (surcharge)	Mechanical linkage: <input type="checkbox"/> Link interlock <input type="checkbox"/> Cable interlock Door interlock: <input type="checkbox"/> Switch body position door interlock(drawer-type) <input type="checkbox"/> Switch on/off state door interlock			(Optional)
	Accessories (surcharge)	Key lock: <input type="checkbox"/> 1 lock 1 key <input type="checkbox"/> 2 locks 1 key <input type="checkbox"/> 3 locks 1 key <input type="checkbox"/> 3 locks 2 keys <input type="checkbox"/> 5 locks 3 keys <input type="checkbox"/> Special custom __lock__ key External transformer: <input type="checkbox"/> External N phase transformer [(3P+N)T] type <input type="checkbox"/> External leakage zero sequence current transformer (E mode) <input type="checkbox"/> External ground current transformer (W) Module: <input type="checkbox"/> PSU-1 Power module <input type="checkbox"/> RU-1 relay module <input type="checkbox"/> ST-DP protocol converting module <input type="checkbox"/> Position signaling devices ( <input type="checkbox"/> Connected <input type="checkbox"/> Test <input type="checkbox"/> Unconnected) <input type="checkbox"/> Mechanical counting device			(Optional)
	The main circuit connection	<input type="checkbox"/> Horizontal connection (default) <input type="checkbox"/> Vertical connection (with L vertical bus-bar) <input type="checkbox"/> Rotation busbar horizontal connection (Drawer In ≤ 3200) <input type="checkbox"/> Rotation busbar vertical connection (drawer-type In ≤ 3200)			(Optional)

Note: The casing current, rated current and auxiliary control voltage must be specified when ordering!  
 Note: 1) Please mark "√" or fill figure in the relative "□" if no mark, we will provide according to conventional.  
 Note: 2) The operational function of the intelligent controller and special requirements require additional costs.  
 Tel.:0577-6287777-6213 Fax :0577-6287777-6288?



NA1-6300X



NA1-4000X



NA1-3200X



NA1-2000X



NA1-1000X

## Configuration instructions

### 1. NA1-2000X~6300X fundamental configurations

- a. Motor-driven:
- Under-voltage instantaneous release;
  - Shunt release;
  - Closing electromagnet;
  - 4 suits of transform contact;
  - Motor driven operating mechanism;
  - M-type Intelligent Controller;
  - Horizontal wiring of main circuit;
  - Doorcase;
  - Element of main circuit;
  - Operating instructions of M-type Intelligent Controller
  - Operating instructions of Air Circuit Breaker;
  - Packing box;
  - Drawer seat (Drawout type)

b. Manual:

- Under-voltage instantaneous release;
- 4 suits of transform contact;
- M-type Intelligent Controller;
- Horizontal wiring of main circuit;
- Doorcase;
- Element of main circuit;
- Operating instructions of M-type Intelligent Controller
- Operating instructions of Air Circuit Breaker;
- Packing box;
- Drawer seat(Drawout type)

### 3. NA1-2000X~6300X operational configuration (additional costs)

- Nonadjustable under voltage delayed release (1s, 3s, 5s);
- Connecting-rod type mechanical interlock (for drawout type);
- Wire-cable mechanical interlock; Button lock; Key lock;
- Door interlock/Locking device;
- External current transformer earthing protection;
- Vertical busbar;
- Rotating busbar (IN≤3200);
- 3NO (normal open) and 3NC (normal close) contacts;
- 4NO and 4NC contacts; 5 groups changeover contacts;
- 3 groups changeover contacts; H type intelligent controller;
- Position signal; Counter; Protecting cover (NA1-2000);
- Double power controller.

### 2. NA1-1000X fundamental configurations

- a. Motor-driven:
- Under-voltage instantaneous release;
  - Shunt release;
  - Closing electromagnet;
  - Motor driven operating mechanism;
  - 4 normal open and 4 normal close auxiliary contacts;
  - M-type Intelligent Controller;
  - Closing and breaking push button lock;
  - Horizontal wiring of main circuit;
  - Doorcase;
  - Element of main circuit;
  - Operating instructions of Air Circuit Breaker;
  - Packing box;
  - Drawer seat(Drawout type)

b. Manual:

- Under-voltage instantaneous release;
- 4 normal open and 4 normal close auxiliary contacts;
- M-type Intelligent Controller;
- Horizontal wiring of main circuit;
- Closing and breaking push button lock;
- Doorcase;
- Element of main circuit;
- Operating instructions of Air Circuit Breaker;
- Packing box;
- Drawer seat(Drawout type)

### 4. NA1-1000X operational configuration (additional costs)

- Under voltage delayed release; wire-cable mechanical interlock;
- key lock; External current transformer earthing protection;
- Vertical busbar; 6 groups changeover contacts;
- H type intelligent controller; Phases barrier, position signal



## Asia Pacific

### China | Global HQ

#### Zhejiang CHINT Electric Co., Ltd.

Address: A3 Building, No. 3655 Sixian Road, Songjiang Shanghai 201614.  
Tel: +86 21 5677 7777  
Fax: +86 21 5677 7777  
Email: global-sales@chintglobal.com  
Website: www.chintglobal.com

### Singapore | Asia Pacific HQ

#### CHINT Global Pte Ltd

Address: 8 Kallang Avenue, #04-06/09 Aperia Office Tower 1, Singapore 339509.  
Tel: +65 6329 3110  
Fax: +65 6329 3159  
Website: www.chintglobal.com

### Sunlight Electrical Pte Ltd

Address: 1 Third Chin Bee Road, Singapore 618679.  
Tel: +65 6741 9055  
Fax: +65 6265 4586  
Email: sales@sunlightgroup.com  
Website: www.sunlightgroup.com

### India

#### CHINT India Energy Solution Private Limited

Address: Discovery Tower, Plot No. A-17, Ground Floor Industrial Area Sector 62 Noida, India 201309.  
Tel: +91 1202 9750 57  
Email: marketing@chint.co.in  
Website: www.chint.co.in

### Philippines

#### CHINT Electric Co., Ltd

Address: Unit 201, Taipan Place, F. Ortigas Jr. Road, Ortigas Center, Pasig City, Metro Manila, Philippines.  
Tel: +63 967 273 0174 / +63 977 017 6320  
Email: liq07@chintglobal.com / wencell@chintglobal.com  
Website: www.chintglobal.com

### Indonesia

#### PT. CHINT Indonesia

Address: Kompleks Prima Center I, Blok C9-10, Jl. Pesing Poglar Jl. Pool PPD No. 11, RT.9/RW.2, Cengkareng, Jakarta Barat.  
Tel: +62 21 5436 3000  
Email: sales@chint-indonesia.com  
Website: www.chint-indonesia.com

### Vietnam

#### CHINT Vietnam Holding Co., Ltd

Address: So 2Bis-4-6, Le Thanh Ton, P. Ben Nghe Quan 1, Ho Chi Minh, Vietnam.  
Tel: +84 0283 8270 015  
Email: marketing.vn@chintglobal.com  
Website: www.chintglobal.vn

### Sunlight Electrical (VN) Co., Ltd

Address: 20 Doc Lap Ave, VSIP, Thuan An City, Binh Duong Province, Vietnam.  
Tel: +84 0274 3743 505  
Email: sales.sev@sunlightgroup-vn.com.vn  
Website: www.sunlightvietnam.com.vn

### Cambodia

#### CHINT (Cambodia) Power Equipment Co., Ltd

Address: No.15, St. 542, Sangkat Boeung Kok 1, Khan Toul Kork, Phnom Penh, Cambodia.  
Tel: +855 23 231 077  
Email: lbin3@chintglobal.com  
Website: www.chintglobal.com

### SchneiTec CHINT Co., Ltd

Address: Ansor Kdam Village, Sna Ansa Commune, Krakor District, Pursat Province, Cambodia  
Tel: +855 09 5353 268  
Email: liubin@schneitec-chint.com.kh / info@schneitec-chint.com.kh  
Website: www.schneitec-chint.com.kh

## Latin America

### Brazil

#### CHINT Elétricos América do Sul Ltda.

Add: Av. Paulista, 1765 - Edifício Scarpa - Conjunto 22, Bela Vista - CEP 01311-200 - São Paulo - SP  
Tel: +55 (11) 3266-7786  
E-mail: chintbr@chint.com

### Peru

#### CHINT LATAM (PERU) S.A.C.

Add: Av. Camino Real No.348, Torre El Pilar, Oficina 603, San Isidro, Lima 27, Peru  
Tel: +51 1 763 4917  
Email: chintlatamperu@chint.com

### Ecuador

#### CHINT ELECTRICS (HONG KONG) LIMITED (Ecuador Branch)

Add.: Calle: REP.DEL SALVADOR Número: 10-84 Intersección: AV NACIONES UNIDAS  
Edificio: CENTRO COMERCIAL MANSION BLANCA  
Email: lufz@chintglobal.com

## Europe

### Italy

CHINT ITALIA INVESTMENT S.R.L.

Add: Via A. Pacinotti 28, 30033 Noale (VE)  
Tel: +39 041.446614 Fax +39 041.5845900  
Cell: +39 335 626 5032

### Turkey

CHİNT TURCA ELEKTRİK SANAYİ VE TİCARET ANONİM ŞİRKETİ

Add: ZÜMRÜTEVLER MAHALLESİ Ural Sokak No:22 No:22/18 Nas Plaza B Block Kat 1  
Maltepe / Istanbul  
Tel: +90216 621 00 55  
Fax: +90216 621 00 50  
E-mail: fatura@chint.com.tr

### Spain

CHINT ELECTRICS S.L.

Add: Calle José Echegaray, Num 8.Parque Empresarial Las RozasEdificio 3,  
Planta Baja, Oficina 7-8.C.P: 28232 Las Rozas (Madrid)  
Tel: +34 91 645 03 53  
E-mail: info@chint.eu

### Czech Republic

NOARK ELECTRIC EUROPE S.R.O.

Add: Sezemická 2757/2, 193 00 Praha 9, Czech Republic  
Registered at Municipal Court in Prague, Section C, Insert 181277  
Tel.: +420 226 203 120  
www.noark-electric.cz

### Kazakhstan

TOO CHINT KZ

Add: RK, Almaty, Ave Dostyk 192/2, BC Green Tower  
Tel: +7 727 325 88 80 +7 727 325 99 90  
Email:chint-kz@chint.com

### Netherland

CHINT ELECTRICS NETHERLANDS B.V.

Add: DE-Entree 139-141,1101 HE Amsterdam,the Netherlands

### Romania

NOARK ELECTRIC S.R.L

Add:Electromagnetica BUSINESS PARK Calea Rahovei nr. 266 - 268  
Corp 3, et. 1, camera 09 Sector 5 , Bucuresti Romania  
Tel.: +40 371 444 920

### Poland

NOARK ELECTRIC SP. Z O.O.

Add:ul. Romana Maya 1, 61-371 Poznań Poland  
Tel.: +48 61 222 67 67  
www.noark-electric.pl

### United Kingdom

CHINT GLOBAL (UK) LIMITED

Add: 4th Floor 1-3 Pemberton Row, London, United Kingdom EC4A 3GB  
Email: chintuk@chintglobal.com

## North America

### Mexico

CHINT SOLAR MEXICO S DE RL DE CV

Add: Av. Paseo de la Reforma 296, Piso 37, Oficina 123  
Juárez, Ciudad de México, 06600  
Tel: +52 1-55-8881-6127  
E-mail: marie.casillas@chint-mexico.com

### United States of America

NOARK Electric (USA) Inc.

Add: 2188 Pomona Blvd, Pomona, CA,91768,USA  
Tel:+1-626-330-7007  
Fax: +1-626-330-8035  
Email: nasales@noark-electric.com

### Canada

NOARK ELECTRIC (USA) INC.

Add:150 N Michigan Avenue, 3300, Chicago, Illinois, United States, 60601

## Latin America

### Brazil

CHINT ELECTRICS SOUTH AMERICA LTD

Add: Avenida Paulista nº 2073 – Conjunto Nacional – Edifício Horsa 1 - Conjunto  
Room 1407/1408 , No.1 Horsa, No. 2073 Paulista, Sao Paulo 01311-300  
Tel: 0055-(11) 3266-7654  
Fax: 0055- (11) 3142-9601  
E-mail: chintlatinamerica@chint.com

### Peru

CHINT LATAM(PERU) S.A.C.

Add.: Camino Real 348 oficina 603, San Isidro, Lima  
Tel.: +51 1 763 4917  
Email: chintlatamperu@chint.com



CHINT GLOBAL PTE. LTD.

Building A3, 3655 Sixian Road,  
Songjiang District, Shanghai, China

Tel: +86-21-5677 7777 Web: www.chintglobal.com

E-mail: global-sales@chintglobal.com

A CHINT COMPANY

